



ΑΝΟΔΟΣ- ΔΗΜ Ι ΣΟΥΑΝΗΣ

1-ΕΛΑΣΤΙΚΟΙ ΣΩΛΗΝΕΣ ΥΨΗΛΗΣ ΠΙΕΣΗΣ ΜΕ ΧΑΛΥΒΔΙΝΑ ΠΛΕΓΜΑΤΑ

	ΚΩΔΙΚΟΣ	ΔΙΑΜΕΤΡΟΣ	ΠΙΕΣΗ(ΑΤΜ.)	
	1-0000A	3/16"	235	SAE100R1AT EN 853
	1-0000	1/4"	225	
	1-0001	5/16"	225	
	1-0002	3/8"	210	
	1-0003	1/2"	175	
	1-0004	5/8"	140	
	1-0005	3/4"	125	
	1-0006	1"	88	
	1-0007	1 1/4"	63	
	1-0008	1 1/2"	50	
	1-0009	2"	40	
	1-0009A	2 3/8"	50	
1-0009B	2 1/2"	50		
1-0009C	3"	35		

	1-0010A	3/16"	400	SAE100R2AT EN 853
	1-0010	1/4"	400	
	1-0011	5/16"	350	
	1-0012	3/8"	345	
	1-0013	1/2"	295	
	1-0014	5/8"	250	
	1-0015	3/4"	215	
	1-0016	1"	175	
	1-0017	1 1/4"	155	
	1-0018	1 1/2"	125	
	1-0019	2"	90	





	1-0022	3/8"	490	SAE100 4SP-SH EN 856
	1-0023	1/2"	420	
	1-0024	5/8"	400	
	1-0025	3/4"	350	
	1-0026	1"	380	
	1-0027	1 1/4"	350	
	1-0028	1 1/2"	300	
	1-0029	2"	250	

	1-0036	1"		SAE100R13
	1-0037	1 1/4"		
	1-0038	1 1/2"		

	1-0000-EQ	1/4"	225	EQUATOR R1AT 135*C
	1-0001-EQ	5/16"	215	
	1-0002-EQ	3/8"	180	
	1-0003-EQ	1/2"	160	
	1-0004-EQ	5/8"	130	
	1-0005-EQ	3/4"	105	
	1-0006-EQ	1"	88	
	1-0007-EQ	1 1/4"	63	
	1-0008-EQ	1 1/2"	50	
	1-0009-EQ	2"	40	
1-0009B-EQ	2 1/2"	40		
1-0009C-EQ	3	35		



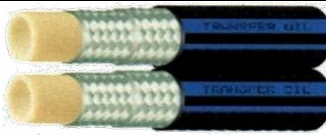

ΑΝΟΔΟΣ- ΔΗΜ Ι ΣΟΥΑΝΗΣ

1-ΕΛΑΣΤΙΚΟΙ ΣΩΛΗΝΕΣ ΥΨΗΛΗΣ ΠΙΕΣΗΣ ΜΕ ΧΑΛΥΒΔΙΝΑ ΠΛΕΓΜΑΤΑ

	ΚΩΔΙΚΟΣ	ΔΙΑΜΕΤΡΟΣ	ΠΙΕΣΗ(ΑΤΜ.)	
	1-0090AA	1/8"	440	ΣΑΕ 100 R8 ΘΕΡΜΟΠΛΑΣΤΙΚΟΣ ΕΝΑ ΑΤΣΑΛΙΝΟ ΠΛΕΓΜΑ ΜΟΝΟΣ
	1-0090A	3/16"	325	
	1-0090	1/4"	315	
	1-0091	5/16"	250	
	1-0092	3/8"	240	
	1-0093	1/2"	200	
	1-0094	5/8"		
	1-0095	3/4"	165	
	1-0090AA-Δ	1/8"	440	ΣΑΕ 100 R8 ΘΕΡΜΟΠΛΑΣΤΙΚΟΣ ΕΝΑ ΑΤΣΑΛΙΝΟ ΠΛΕΓΜΑ ΔΙΠΛΟΣ
	1-0090A-Δ	3/16"	325	
	1-0090-Δ	1/4"	315	
	1-0091-Δ	5/16"	250	
	1-0092-Δ	3/8"	240	
	1-0093-Δ	1/2"	200	
	1-0094-Δ	5/8"		
	1-0095-Δ	3/4"		
1-0096-Δ	1"			
	1-0190AB	5/32"	200	ΣΑΕ 100 R7 ΘΕΡΜΟΠΛΑΣΤΙΚΟΣ ΛΙΝΟ ΠΛΕΓΜΑ ΜΟΝΟΣ
	1-0190AA	1/8"	200	
	1-0190A	3/16"	200	
	1-0190	1/4"	200	
	1-0191	5/16"	190	
	1-0192	3/8"	175	
	1-0193	1/2"	140	
	1-0194	5/8"		
	1-0195	3/4"	165	
	1-0196	1"		
	1-0190AA-Δ	1/8"	200	ΣΑΕ 100 R7 ΘΕΡΜΟΠΛΑΣΤΙΚΟΣ ΛΙΝΟ ΠΛΕΓΜΑ ΔΙΠΛΟΣ
	1-0190A-Δ	3/16"	200	
	1-0190-Δ	1/4"	200	
	1-0191-Δ	5/16"	190	
	1-0192-Δ	3/8"	175	
	1-0193-Δ	1/2"	140	
	1-0190-R6	1/4"	28	ΣΑΕ 100 R6 ΠΙΕΣΕΩΣ
	1-0191-R6	5/16"	28	
	1-0192-R6	3/8"	28	
	1-0193-R6	1/2"	28	
	1-0194-R6	5/8"	24	
	1-0195-R6	3/4"	21	
	1-0196-R6	1"	20	

ΑΝΟΔΟΣ- ΔΗΜ Ι ΣΟΥΑΝΗΣ

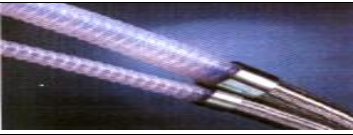
1-ΕΙΔΙΚΟΙ ΕΛΑΣΤΙΚΟΙ ΣΩΛΗΝΕΣ (R5-TEFLON-ΠΛΥΝΤΗΡΙΟΥ-ΤΡΟΦΙΜΩΝ-ΟΞΕΩΝ)

	ΚΩΔΙΚΟΣ	ΔΙΑΜΕΤΡΟΣ	ΠΙΕΣΗ(ΑΤΜ.)	
	1-0040	1/4"	207	SAE100 R5
	1-0041	5/16"	155	
	1-0042	13/32"	138	
	1-0043	1/2"	123	
	1-0044	5/8"	103	
	1-0045	7/8"	55	
	1-0046	1 1/8"	43	
	1-0047	1 3/8"	34	
	1-0048	1 13/16"	24	
	1-0049	2 3/8"	50	
	1-0052	3/8"	100	ΙΝΟΧ ΑΝΟΞΕΙΔΩΤΟΣ ΚΑΤΑΛΛΗΛΟΣ ΓΙΑ ΕΦΑΡΜΟΓΕΣ ΑΤΜΟΥ ΒΑΡΕΩΣ ΤΥΠΟΥ
	1-0053	1/2"	90	
	1-0054	5/8"		
	1-0055	3/4"	55	
	1-0056	1"	48	
	1-0057	1 1/4"	38	
	1-0058	1 1/2"	34	
	1-0059	2"	31	
	1-0059A	2 1/2"		
	1-0059B	3"		
	1-0059C	4"		
	1-0060AA	1/8"	285	TEFLON ΚΑΤΑΛΛΗΛΟΣ ΓΙΑ ΕΦΑΡΜΟΓΕΣ ΣΕ ΥΨΗΛΕΣ ΘΕΡΜΟΚΡΑΣΙΕΣ 170*С
	1-0060A	3/16"	200	
	1-0060	1/4"	241	
	1-0061	5/16"	230	
	1-0062	3/8"	219	
	1-0063	1/2"	161	
	1-0064	5/8"	138	
	1-0065	3/4"	144	
	1-0066	1"	92	
		1-0063-1	1/2"	
1-0064-1		5/8"	125	
1-0065-1		3/4"	132	
1-0066-1		1"	65	
	1-1-0003	12X16		ΠΛΑΣΤΙΚΟΠΟΙΗΜΕΝΟ ΠΡΟΣΤΑΤΕΥΤΙΚΟ SPIRAL
	1-1-0004	16X20		
	1-1-0005	20X25		
	1-1-0006	27X32		
	1-1-0013	35MM		ΥΦΑΣΜΑΤΙΝΟ ΠΡΟΣΤΑΤΕΥΤΙΚΟ ΠΟΥΚΑΜΙΣΟ
	1-1-0014	45MM		
	1-1-0015	55MM		
	1-1-0016	65MM		
	1-1-0017	80MM		
	1-1-0018	90MM		
	1-1-0019	120MM		
	1-1-0020	150MM		

ΑΝΟΔΟΣ- ΔΗΜ Ι ΣΟΥΑΝΗΣ

1-ΕΙΔΙΚΟΙ ΕΛΑΣΤΙΚΟΙ ΣΩΛΗΝΕΣ (R5-TEFLON-ΠΛΥΝΤΗΡΙΟΥ-ΤΡΟΦΙΜΩΝ-ΟΞΕΩΝ)

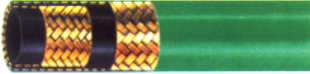
	ΚΩΔΙΚΟΣ	ΔΙΑΜΕΤΡΟΣ	ΠΙΕΣΗ(ΑΤΜ.)	
	1-0070R1	1/4"	250	ΠΛΥΝΤΗΡΙΟΥ 155°C
	1-0071R1	5/16"	240	
	1-0072R1	3/8"	200	
	1-0073R1	1/2"		

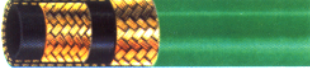
	1-0070R2	1/4"	400
	1-0071R2	5/16"	400
	1-0072R2	3/8"	380
	1-0073R2	1/2"	

	1-0181	5/16"	ΑΤΣΑΛΙΝΟ	FREON 134A ΜΕ ΑΤΣΑΛΙΝΟ ΠΛΕΓΜΑ
	1-0182	13/32"	ΑΤΣΑΛΙΝΟ	
	1-0183	1/2"	ΑΤΣΑΛΙΝΟ	
	1-0184	5/8"	ΑΤΣΑΛΙΝΟ	
	1-0185	7/8"	ΑΤΣΑΛΙΝΟ	
	1-0186	1 1/8"	ΑΤΣΑΛΙΝΟ	

	1-0081	5/16"	ΛΙΝΟ	FREON 134A ΜΕ ΛΙΝΟ ΠΛΕΓΜΑ
	1-0082	13/32"	ΛΙΝΟ	
	1-0083	1/2"	ΛΙΝΟ	
	1-0084	5/8"	ΛΙΝΟ	

ΕΛΑΣΤΙΚΟΙ ΣΩΛΗΝΕΣ ΜΕΣΗΣ-ΧΑΜΗΛΗΣ ΠΙΕΣΗΣ

	ΚΩΔΙΚΟΣ	ΔΙΑΜΕΤΡΟΣ	ΠΙΕΣΗ(ΑΤΜ.)	
	1-0303	1/2"	17	ΣΩΛΗΝΑΣ ΑΤΜΟΥ 17/51ΑΤΜ
	1-0304	5/8"	17	
	1-0305	3/4"	17	
	1-0306	1"	17	
	1-0307	1 1/4"	17	
	1-0308	1 1/2"	17	
	1-0309	2"	17	







	1-0315	3/4"	20	ΣΩΛΗΝΑΣ ΑΕΡΟΣΦΥΡΩΝ 20/60ΑΤΜ
	1-0316	1"	20	
	1-0317	1 1/4"	20	
	1-0318	1 1/2"	20	
	1-0319	2"	20	

	1-0326	1"	12	ΣΩΛΗΝΑΣ ΑΜΜΟΒΟΛΗΣ 12ΒΑΡ
	1-0327	1 1/4"	12	
	1-0327A	1 3/8"	12	
	1-0328	1 1/2"	12	
	1-0329	2"	12	

	1-0377A	1 3/8"	40	ΣΩΛΗΝΑΣ ΣΟΒΑ-ΜΠΕΤΟΝ 40-120ΒΑΡ
	1-0378	1 1/2"	40	
	1-0379	2"	40	
	1-0379A	2 1/2"	40	

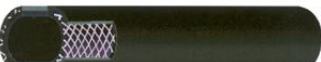



ΑΝΟΔΟΣ- ΔΗΜ Ι ΣΟΥΑΝΗΣ

1-ΕΛΑΣΤΙΚΟΙ ΣΩΛΗΝΕΣ ΜΕΣΗΣ-ΧΑΜΗΛΗΣ ΠΙΕΣΗΣ

	ΚΩΔΙΚΟΣ	ΔΙΑΜΕΤΡΟΣ	ΠΙΕΣΗ(ΑΤΜ.)	
	1-0231	5/16"	10/30.	ΣΩΛΗΝΕΣ ΒΡΥΣΗΣ-ΚΗΠΩΝ ΔΙΑΦΑΝΗΣ
	1-0232	3/8"	10/30.	
	1-0233	1/2"	10/30.	
	1-0234	5/8"	10/30.	
	1-0235	3/4"	10/30.	
	1-0236	1"	10/30.	
	1-0240	1/4"	10/30.	ΣΩΛΗΝΕΣ ΑΕΡΟΣ-ΝΕΡΟΥ 10/30ΑΤΜ
	1-0241	5/16"	10/30.	
	1-0242	3/8"	10/30.	
	1-0243	1/2"	10/30.	
	1-0244	5/8"	10/30.	
	1-0245	3/4"	10/30.	
	1-0246	1"	10/30.	
	1-0250	1/4"	20/60	ΣΩΛΗΝΕΣ ΑΕΡΟΣ-ΝΕΡΟΥ 20/60ΑΤΜ
	1-0251	5/16"	20/60	
	1-0252	3/8"	20/60	
	1-0252A	9/16"	20/60	
	1-0253	1/2"	20/60	
	1-0254	5/8"	20/60	
	1-0255	3/4"	20/60	
	1-0256	1"	20/60	
	1-0263	1/2"	10/30.	ΣΩΛΗΝΕΣ ΖΕΣΤΟΥ ΝΕΡΟΥ 120 *C 10/30BAR
	1-0264	5/8"	10/30.	
	1-0265	3/4"	10/30.	
	1-0266	1"	10/30.	
	1-0270	1/4"	20/60	ΟΞΥΓΟΝΟ-ΑΣΕΤΥΛΙΝΗ
	1-0271	5/16"	20/60	
	1-0272	3/8"	20/60	
	1-0271-1	5/16"	25/75	ΒΟΥΤΑΝΙΟΥ
	1-0270Δ	1/4"	20/60 ΔΙΠΛΟ	ΟΞΥΓΟΝΟ-ΑΣΕΤΥΛΙΝΗ
	1-0271Δ	5/16"	20/60 ΔΙΠΛΟ	
	1-0272Δ	3/8"	20/60 ΔΙΠΛΟ	

ΑΝΟΔΟΣ- ΔΗΜ Ι ΣΟΥΑΝΗΣ

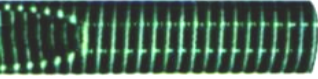
1-ΕΛΑΣΤΙΚΟΙ ΣΩΛΗΝΕΣ ΜΕΣΗΣ-ΧΑΜΗΛΗΣ ΠΙΕΣΗΣ

	ΚΩΔΙΚΟΣ	ΔΙΑΜΕΤΡΟΣ	ΠΙΕΣΗ(ΑΤΜ.)	
	1-0281	5/16"	40/120	ΨΕΚΑΣΜΟΥ ΓΕΩΡΓΙΚΩΝ ΦΑΡΜΑΚΩΝ 40/120ΑΤΜ
	1-0282	3/8"	40/120	
	1-0283	1/2"	40/120	
	1-0291	5/16"	80/240	ΨΕΚΑΣΜΟΥ ΓΕΩΡΓΙΚΩΝ ΦΑΡΜΑΚΩΝ 80/240ΑΤΜ
	1-0292	3/8"	80/240	
	1-0293	1/2"	80/240	
	1-0603	1/2"		HELLISTEEL ΜΗ ΤΟΞΙΚΟ ΚΑΤΑΛΛΗΛΟΣ ΓΙΑ ΤΡΟΦΙΜΑ
	1-0604	5/8"		
	1-0605	3/4"		
	1-0606	1"		
	1-0607	1 1/4"		
	1-0607A	1 3/8"		
	1-0607AA	1 9/16"		
	1-0608	1 1/2"		
	1-0608A	1 3/4"		
	1-0609	2"		
	1-0609A	2 3/8"		
	1-0600-63	2 1/2"		
	1-0600-75	3"		
	1-0605-N	3/4"		ΠΡΑΣΙΝΟΣ ΝΕΡΟΣΩΛ
	1-0606-N	1"		
	1-0607-N	1 1/4"		
	1-0608-N	1 1/2"		
	1-0609-N	2"		
	1-0600-63-N	2 1/2"		
	1-0600-75-N	3"		
	1-0600-102-N	4"		
	1-0610-63	Φ63		ΕΞΑΕΡΙΣΜΟΥ ΓΚΡΙ
	1-0610-76	Φ76		
	1-0610-76-BT	Φ76		
	1-0610-100	Φ100		
	1-0620-20	Φ20		ΜΕΤΑΛΛΙΚΟ SPIRAL ΕΞΑΤΜΙΣΕΩΝ ΠΙΣΣΑΣ-ΑΤΜΟΥ
	1-0620-25	Φ25		
	1-0620-32	Φ32		
	1-0620-35	Φ35		
	1-0620-40	Φ40		
	1-0620-45	Φ45		
	1-0620-50	Φ50		
	1-0620-60	Φ60		
	1-0620-65	Φ65		
	1-0620-70	Φ70		
	1-0620-75	Φ75		
	1-0620-80	Φ80		
	1-0620-90	Φ90		
	1-0620-100	Φ100		
	1-0620-110	Φ110		
1-0620-115	Φ115			
1-0620-125	Φ125			
1-0620-130	Φ130			

ΑΝΟΔΟΣ- ΔΗΜ Ι ΣΟΥΑΝΗΣ

1-ΕΛΑΣΤΙΚΟΙ ΣΩΛΗΝΕΣ ΜΕΣΗΣ-ΧΑΜΗΛΗΣ ΠΙΕΣΗΣ

	ΚΩΔΙΚΟΣ	ΔΙΑΜΕΤΡΟΣ	ΠΙΕΣΗ(ΑΤΜ.)	
	1-0255-22	22X30	10	ΣΩΛΗΝΕΣ ΑΕΡΟΣ-ΝΕΡΟΥ
	1-0200-28	28X36	10	
	1-0200-32	32X42	10	
	1-0201-32	32X44	20	
	1-0200-35	35X46	10	
	1-0200-35A	35X48	40	
	1-0200-38	38X50	10	
	1-0201-38	38X50	20	
	1-0200-40	40X52	20	
	1-0200-45	45X55	10	
	1-0200-51	51X61	10	
	1-0201-51	51X65	20	
	1-0200-55	55X65	20	
	1-0200-57	57X67	10	
	1-0200-60	60X70	10	
	1-0200-63	63X78	10	
	1-0201-63	63X79	20	
	1-0200-70	70X80	10	
	1-0200-76	76X88	10	
	1-0201-76	76X92	20	
	1-0200-80	80X96	10	
	1-0200-90	90X110	10	
	1-0200-102	102X114	10	
	1-0200-110	110X122	10	
	1-0200-115	115X125	10	
	1-0200-125	125X140	10	
	1-0200-140	140X155	10	
1-0200-150	150X165	10		

	1-0200-32S	32X41	10	ΚΟΛΛΑΡΟ SPIRAL ΑΝΑΡΟΦΗΣΗΣ ΑΕΡΟΣ-ΝΕΡΟΥ
	1-0200-35S	35X44	10	
	1-0200-38S	38X47	10	
	1-0200-45S	45X54	10	
	1-0200-51S	51X60	10	
	1-0200-57S	57X69	10	
	1-0200-63S	63X72	10	
	1-0200-70S	70X84	10	
	1-0200-76S	76X86	10	
	1-0200-80S	80X96	10	
	1-0200-90S	90X100	10	
	1-0200-102S	102X112	10	
	1-0200-115S	115X124	10	
	1-0200-125S	125X142	10	
	1-0200-150S	150X166	10	

ΑΝΟΔΟΣ- ΔΗΜ Ι ΣΟΥΑΝΗΣ





1-ΕΛΑΣΤΙΚΟΙ ΣΩΛΗΝΕΣ ΜΕΣΗΣ-ΧΑΜΗΛΗΣ ΠΙΕΣΗΣ

	ΚΩΔΙΚΟΣ	ΔΙΑΜΕΤΡΟΣ	ΠΙΕΣΗ(ΑΤΜ.)	
	1-0210-32S	32X41	12	ΚΟΛΛΑΡΟ SPIRAL ΑΝΑΡΟΦΗΣΗΣ ΛΑΔΙΟΥ
	1-0210-38S	38X47	12	
	1-0210-40S	40X49	12	
	1-0210-42S	42X51	12	
	1-0210-45S	45X54	12	
	1-0210-51S	51X60	12	
	1-0210-60S	60X69	12	
	1-0210-63S	63X72	12	
	1-0210-70S	70X80	12	
	1-0210-76S	76X86	12	
	1-0210-80S	80X90	12	
	1-0210-90S	90X100	12	
	1-0210-102S	102X112	12	
	1-0210-125S	125X163	12	
	1-0210-150S	150X168	12	

	ΚΩΔΙΚΟΣ	ΔΙΑΜΕΤΡΟΣ	ΠΙΕΣΗ(ΑΤΜ.)	
	1-0220-18	18X24	5	ΚΟΛΛΑΡΑ ΜΕΤΡΟΥ RADIATOR 120*C
	1-0220-20	20X27	5	
	1-0220-22	22X28	5	
	1-0220-25	25X32	5	
	1-0220-28	28X36	5	
	1-0220-30	30X38	5	
	1-0220-32	32X40	5	
	1-0220-35	35X43	5	
	1-0220-38	38X47	5	
	1-0220-40	40X49	5	
	1-0220-42	42X50	5	
	1-0220-45	45X54	5	
	1-0220-48	48X57	5	
	1-0220-50	50X60	5	
	1-0220-57	57X65	5	
	1-0220-60	60X69	5	
	1-0220-63	63X74	5	
	1-0220-70	70X80	5	
	1-0220-75	75X83	5	
	1-0220-80	80X90	5	
1-0220-90	90X102	5		
1-0220-100	100X113	5		
1-0220-120	120X134	5		

ΑΝΟΔΟΣ- ΔΗΜ Ι ΣΟΥΑΝΗΣ

1-ΕΛΑΣΤΙΚΟΙ ΣΩΛΗΝΕΣ ΜΕΣΗΣ-ΧΑΜΗΛΗΣ ΠΙΕΣΗΣ

	ΚΩΔΙΚΟΣ	ΔΙΑΜΕΤΡΟΣ	ΠΙΕΣΗ(ΑΤΜ.)	
	1-0700-50	50MM		ΣΩΛΗΝΑΣ ΕΞΑΕΡΙΣΜΟΥ ΘΕΡΜΟΑΝΘΕΚΤΙΚΟΣ
	1-0700-60	60MM		
	1-0700-63	63MM		
	1-0700-70	70MM		
	1-0700-75	75MM		
	1-0700-80	80MM		
	1-0700-90	90MM		
	1-0700-100	100MM		
	1-0700-125	125MM		
	1-0700-140	140MM		
	1-0700-150	150MM		
	1-0700-180	180MM		
	1-0700-200	200MM		
	1-0710-40	40MM		ΣΩΛΗΝΑΣ ΕΞΑΕΡΙΣΜΟΥ ΔΙΑΦΑΝΗΣ
	1-0710-50	50MM		
	1-0710-60	60MM		
	1-0710-63	63MM		
	1-0710-70	70MM		
	1-0710-75	75MM		
	1-0710-90	90MM		
	1-0710-100	100MM		
	1-0710-110	110MM		
	1-0710-120	120MM		
	1-0710-125	125MM		
	1-0710-140	140MM		
	1-0710-150	150MM		
	1-0710-160	160MM		
	1-0710-180	180MM		
	1-0710-200	200MM		
	1-0710-250	250MM		
1-0710-300	300MM			
	1-0800-32	Φ32	9	ΣΩΛΗΝΑΣ ΠΥΡΟΣΒΕΣΗΣ ΠΟΤΙΣΜΑΤΟΣ LAY FLAT
	1-0800-38	Φ38	8	
	1-0800-45	Φ45	8	
	1-0800-50	Φ50	8	
	1-0800-63	Φ63	8	
	1-0800-75	Φ75	7	
	1-0800-90	Φ90	7	
	1-0800-102	Φ102	7	
	1-0900-25	25MM		ΣΩΛΗΝΑΣ SPIRAL ΣΙΛΙΚΟΝΗΣ ΑΕΡΟΣ 300°C
	1-0900-32	32MM		
	1-0900-38	38MM		
	1-0900-41	41MM		
	1-0900-44	44MM		
	1-0900-51	51MM		
	1-0900-55	55MM		
	1-0900-60	60MM		
	1-0900-63	63MM		
	1-0900-70	70MM		
	1-0900-76	76MM		
	1-0900-80	80MM		
	1-0900-90	90MM		
	1-0900-102	102MM		
1-0900-110	110MM			
1-0900-120	120MM			

ΑΝΟΔΟΣ- ΔΗΜ Ι ΣΟΥΑΝΗΣ

1-ΕΛΑΣΤΙΚΟΙ ΣΩΛΗΝΕΣ ΜΕΣΗΣ-ΧΑΜΗΛΗΣ ΠΙΕΣΗΣ

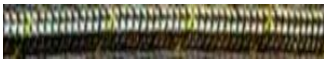
	ΚΩΔΙΚΟΣ	ΔΙΑΜΕΤΡΟΣ	ΠΙΕΣΗ(ΑΤΜ.)	
	1-0330AA	3/16"	10	ΣΩΛΗΝΕΣ ΠΕΤΡΕΛΑΙΟΥ FLEXIBLE
	1-0330	1/4"	10	
	1-0331	5/16"	10	
	1-0332	3/8"	10	
	1-0333	1/2"	10	
	1-0334	5/8"	10	
	1-0335	3/4"	10	
	1-0336	1"	10	

	1-0340AZ	3,2MM	10	ΣΩΛΗΝΑΣ ΒΕΝΖΙΝΗΣ ΠΛΕΚΤΟΣ
	1-0340AA	4,0MM	10	
	1-0340A	5,0MM	10	
	1-0340	6,0MM	10	
	1-0341	8,0MM	10	
	1-0342	10,0MM	10	
	1-0343	12,0MM	10	

	1-0350AA	3/16"	16	ΣΩΛΗΝΑΣ ΚΑΥΣΙΜΟΥ-ΛΑΔΙΟΥ ΛΕΙΟΣ
	1-0350	1/4"	16	
	1-0351	5/16"	16	
	1-0352	3/8"	16	
	1-0353	1/2"	16	
	1-0354	5/8"	16	

	1-0365	3/4"	10	ΣΩΛΗΝΑΣ ΠΕΤΡΕΛΑΙΟΥ ΜΑΝΙΚΑΣ
	1-0366	1"	10	
	1-0367	1 1/4"	10	
	1-0368	1 1/2"	10	
	1-0369	2"	10	





	1-0371	5/16"	30	ΣΩΛΗΝΑΣ ΦΥΣΙΚΟΥ ΑΕΡΙΟΥ
	1-0373	1/2"	30	

	1-0500-04	4X10	16	ΣΩΛΗΝΑΣ LPG ΜΕ ΛΙΝΑ ΠΛΕΓΜΑΤΑ
	1-0500-05	5X11	16	
	1-0500-06	6X13	16	
	1-0500-12	12X19	16	

	1-0501-05	3/16"	30	ΣΩΛΗΝΑΣ LPG ΘΕΡΜΟΠΛΑΣΤΙΚΟΣ ΤΕΦΛΟΝ
	1-0501-06	1/4"	30	
	1-0501-08	5/16"	30	
	1-0501-10	3/8"	30	





ΑΝΟΔΟΣ- ΔΗΜ Ι ΣΟΥΑΝΗΣ

1-ΕΛΑΣΤΙΚΟΙ ΣΩΛΗΝΕΣ ΜΕΣΗΣ-ΧΑΜΗΛΗΣ ΠΙΕΣΗΣ

	ΚΩΔΙΚΟΣ	ΔΙΑΜΕΤΡΟΣ	ΠΙΕΣΗ(ΑΤΜ.)	
	1-0400AA	3/16"	11	ΣΩΛΗΝΑΣ ΠΟΛΥΑΜΙΔΙΟΥ (ΠΛΑΣΤΙΚΟΣ) ΙΝΤΖΑ
	1-0400A	1/8"	11	
	1-0400	1/4"	11	
	1-0401	5/16"	11	
	1-0402	3/8"	11	
	1-0403	1/2"	11	
	1-0404	5/8"	11	
	1-0410AA	4X2	11	ΣΩΛΗΝΑΣ ΠΟΛΥΑΜΙΔΙΟΥ (ΠΛΑΣΤΙΚΟΣ) ΜΕΤΡΙΚΟ
	1-0410AB	4X3	11	
	1-0410A	6X3	11	
	1-0410	6X4	11	
	1-0410B	7X5	11	
	1-0411	8X5	11	
	1-0411A	8X6	11	
	1-0411B	9X6	11	
	1-0412	10X7	11	
	1-0412A	10X7,5	11	
	1-0412B	10X8	11	
	1-04121	11X8	11	
	1-0413	12x9	11	
1-0413A	12x10	11		
1-04132	14X10	11		
1-04131	15x12	11		
1-04131A	15x12,5	11		
1-0414	16X12	11		
1-0415	18x15	11		
	1-0411AEL	8X5,5	16	ΣΩΛΗΝΑΣ ΕΛΑΣΤΟΛΑΝ ΚΛΑΔΕΥΤΙΚΟΥ
	1-0411BEL	8X6	16	
	1-0412AEL	10X7,5	16	
	1-0412BEL	10X8	11	
	1-0420	6X4	30M	ΣΩΛΗΝΑΣ SPIRAL RILSAN
	1-0421A	8X6	30M	
	1-0422B	10X8	30M	
	1-0423A	12X10	30M	
	1-00421AA	8X6-1/4"ΘΗΛΥΚΟ L=7,5M		ΣΩΛΗΝΑΣ SPIRAL ΑΚΡΑ 1/4" ΘΗΛΥΚΑ
	1-00421A	8X6-1/4"ΘΗΛΥΚΟ L=15M		
	1-0430AA	4X8	7	ΣΩΛΗΝΑΣ NYLON ΔΙΑΦΑΝΗΣ
	1-0430	6X10	7	
	1-0431	8X11	7	
	1-0432	10X14	7	
	1-0433	13X17	7	
	1-0434	16X20	7	
	1-0435	19X23	7	
	1-0443TRA	12X9 16X1,5 ΑΡΣΕΝΙΚΟ		ΣΩΛΗΝΑΣ ΑΕΡΟΣ ΤΡΑΚΤΟΡΑ 18X1,5
	1-0443TRB	12X9 22X1,5 ΑΡΣΕΝΙΚΟ		

ΑΝΟΔΟΣ- ΔΗΜ Ι ΣΟΥΑΝΗΣ

2-ΡΑΚΟΡ ΥΔΡΑΥΛΙΚΗΣ ΠΡΕΣΣΑΣ-ΣΠΕΙΡΩΜΑ ΙΝΤΣΑΣ BSP

	ΚΩΔΙΚΟΣ	ΔΙΑΣ.ΣΩΛΗΝΑ	ΣΠΕΙΡΩΜΑ		
	2-1000AA	3/16"	1/8"X28	ΘΗΛΥΚΑ ΡΑΚΟΡ ΙΝΤΣΑΣ BSP 60*	
	2-1000AB	3/16"	1/4"X19		
	2-1000	1/4"	1/8"X28		
	2-1000A	1/4"	1/4"X19		
	2-1000B	1/4"	3/8"X19		
	2-1000C	1/4"	1/2"X14		
	2-1001	5/16"	1/4"X19		
	2-1001A	5/16"	3/8"X19		
	2-1001B	5/16"	1/2"X14		
	2-1002	3/8"	1/4"X19		
	2-1002A	3/8"	3/8"X19		
	2-1002ΑΠ	3/8"	3/8"X19		ΠΕΡΙΣΤΡΟΦΗΣ
	2-1002B	3/8"	1/2"X14		
	2-1003	1/2"	3/8"X19		
	2-1003A	1/2"	1/2"X14		
	2-1003B	1/2"	5/8"		
	2-1003C	1/2"	3/4"		
	2-1004	5/8"	5/8"X14		
	2-1004A	5/8"	3/4"X14		
	2-1005A	3/4"	3/4"X14		
	2-1005B	3/4"	1"X11		
	2-1006	1"	3/4"		
	2-1006A	1"	1"X11		
	2-1006B	1"	1 1/4"X11		
	2-1007	1 1/4"	1 1/4"X11		
	2-1008	1 1/2"	1 1/2"X11		
	2-1009	2"	2"X11		
		2-1010A	1/4"	1/4"X19	ΘΗΛΥΚΑ ΡΑΚΟΡ ΙΝΤΣΑΣ ΕΔΡΑ UNF
		2-1012A	3/8"	3/8"X19	
		2-1013A	1/2"	1/2"X14	
2-1015A		3/4"	3/4"X14		
2-1016A		1"	1"X11		
	2-1210A	1/4"	1/4"X19	ΘΗΛΥΚΑ ΡΑΚΟΡ ΙΝΤΣΑΣ ΕΔΡΑ UNF 90	
	2-1212A	3/8"	3/8"X19		
	2-1213A	1/2"	1/2"X14		
	2-1215A	3/4"	3/4"X14		
	2-1216A	1"	1"X11		
	2-10ΓΕ3A	3/8"	1/2"X14 FLAT	ΡΑΚΟΡ ΓΕΡΑΝΩΝ ΙΝΤΣΑΣ FLAT(ΙΣΙΟ ΠΡΟΣΩΠΟ)	
	2-12ΓΕ3A	3/8"	1/2"X14FL-90*		
	2-10ΓΕ3C	1/2"	1/2"X14FLAT		
	2-12ΓΕ3C	1/2"	1/2"X14FL-90*		
	2-10ΓΕ5A	1/2"	3/4"X14FLAT		
	2-12ΓΕ5A	1/2"	3/4"X14FL-90*		
	2-10ΓΕ5C	3/4"	3/4"X14FLAT		
2-12ΓΕ5C	3/4"	3/4"X14FL-90*			

ΑΝΟΔΟΣ- ΔΗΜ Ι ΣΟΥΑΝΗΣ

2-ΡΑΚΟΡ ΥΔΡΑΥΛΙΚΗΣ ΠΡΕΣΣΑΣ-ΣΠΕΙΡΩΜΑ ΙΝΤΣΑΣ BSP

ΚΩΔΙΚΟΣ	ΔΙΑΣ.ΣΩΛΗΝΑ	ΣΠΕΙΡΩΜΑ	
 2-1100AA	3/16"	1/8"X28	ΑΡΣΕΝΙΚΑ ΡΑΚΟΡ ΙΝΤΣΑΣ BSP 60*
2-1100AB	3/16"	1/4"X19	
2-1100	1/4"	1/8"X28	
2-1100A	1/4"	1/4"X19	
2-1100B	1/4"	3/8"X19	
2-1100C	1/4"	1/2"X14	
2-1101	5/16"	1/4"X19	
2-1101A	5/16"	3/8"X19	
2-1101B	5/16"	1/2"X14	
2-1102A	3/8"	3/8"X19	
2-1102B	3/8"	1/2"X14	
2-1103	1/2"	3/8"X19	
2-1103A	1/2"	1/2"X14	
2-1103B	1/2"	5/8"X14	
2-1103C	1/2"	3/4"X14	
2-1104	5/8"	5/8"X14	
2-1104A	5/8"	3/4"X14	
2-1105	3/4"	3/4"X14	
2-1105B	3/4"	1"X11	
2-1106	1"	1"X11	
2-1107	1 1/4"	1 1/4"X11	
2-1108	1 1/2"	1 1/2"X11	
2-1109	2"	2"X11	

 2-1100AA-K	3/16"	1/8"X28	ΑΡΣΕΝΙΚΑ ΡΑΚΟΡ ΙΝΤΣΑΣ BSPT
2-1100AB-K	3/16"	1/4"X18	
2-1100A-K	1/4"	1/8"X28	
2-1100B-K	1/4"	1/4"X18	
2-1101A-K	5/16"	3/8"X18	
2-1102A-K	3/8"	3/8"X18	
2-1102B-K	3/8"	1/2"X14	
2-1103A-K	1/2"	1/2"X14	
2-1105-K	3/4"	3/4"X14	
2-1106-K	1"	1"X11,5	
2-1107-K	1 1/4"	1 1/4"X11,5	
2-1108-K	1 1/2"	1 1/2"X11,5	
2-1109-K	2"	2"X11,5	

 2-1110A	1/4"	1/4"X19	ΑΡΣΕΝΙΚΑ ΡΑΚΟΡ ΙΝΤΣΑΣ BSP 37* ΕΞΩΤΕΡΙΚΟ ΚΩΝΟ
2-1112A	3/8"	3/8"X19	
2-1113A	1/2"	1/2"X14	
2-1115A	3/4"	3/4"X14	
2-1116A	1"	1"X11	

ΑΝΟΔΟΣ- ΔΗΜ Ι ΣΟΥΑΝΗΣ

2-ΡΑΚΟΡ ΥΔΡΑΥΛΙΚΗΣ ΠΡΕΣΣΑΣ-ΣΠΕΙΡΩΜΑ ΙΝΤΣΑΣ BSP

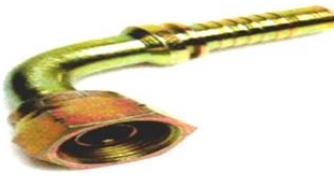
ΚΩΔΙΚΟΣ	ΔΙΑΣ.ΣΩΛΗΝΑ	ΣΠΕΙΡΩΜΑ	
 2-1200AA	3/16"	1/8"X28	ΓΩΝΙΑ 90* ΙΝΤΣΑΣ BSP 60*
2-1200AB	3/16"	1/4"X19	
2-1200	1/4"	1/8"X28	
2-1200A	1/4"	1/4"X19	
2-1200B	1/4"	3/8"X19	
2-1200C	1/4"	1/2"X14	
2-1201	5/16"	1/4"X19	
2-1201A	5/16"	3/8"X19	
2-1201B	5/16"	1/2"X14	
2-1202A	3/8"	3/8"X19	
2-1202B	3/8"	1/2"X14	
2-1203	1/2"	3/8"X19	
2-1203A	1/2"	1/2"X14	
2-1203B	1/2"	5/8"	
2-1203C	1/2"	3/4"	
2-1204	5/8"	5/8"X14	
2-1204A	5/8"	3/4"X14	
2-1205	3/4"	3/4"X14	
2-1205B	3/4"	1"X11	
2-1206	1"	1"X11	
2-1207	1 1/4"	1 1/4"X11	
2-1208	1 1/2"	1 1/2"X11	
2-1209	2"	2"X11	

 2-1300AA	3/16"	1/8"X28	ΓΩΝΙΑ 45* ΙΝΤΣΑΣ BSP 60*
2-1300AB	3/16"	1/4"X19	
2-1300	1/4"	1/8"X28	
2-1300A	1/4"	1/4"X19	
2-1300B	1/4"	3/8"X19	
2-1301	5/16"	1/4"X19	
2-1301A	5/16"	3/8"X19	
2-1302A	3/8"	3/8"X19	
2-1302B	3/8"	1/2"X14	
2-1303	1/2"	3/8"X19	
2-1303A	1/2"	1/2"X14	
2-1304	5/8"	5/8"X14	
2-1304A	5/8"	3/4"X14	
2-1305	3/4"	5/8"X14	
2-1305A	3/4"	3/4"X14	
2-1305B	3/4"	1"X11	
2-1306	1"	1"X11	
2-1307	1 1/4"	1 1/4"X11	
2-1308	1 1/2"	1 1/2"X11	
2-1309	2"	2"X11	

ΑΝΟΔΟΣ- ΔΗΜ Ι ΣΟΥΑΝΗΣ

2-ΡΑΚΟΡ ΥΔΡΑΥΛΙΚΗΣ ΠΡΕΣΣΑΣ ΣΠΕΙΡΩΜΑ ΜΕΤΡΙΚΟ

	ΚΩΔΙΚΟΣ	ΔΙΑΣ.ΣΩΛΗΝΑ	ΣΠΕΙΡΩΜΑ		
	2-2000AA	3/16"	12X1,5-6L	ΘΗΛΥΚΑ ΡΑΚΟΡ ΜΕΤΡΙΚΑ 24*	
	2-2000.	1/4"	12X1,5-6L		
	2-2000D	1/4"	14X1,5-6S		
	2-2000A	1/4"	14X1,5-8L		
	2-2000E	1/4"	16X1,5-8S		
	2-2000B	1/4"	16X1,5-10L		
	2-2000F	1/4"	16X1,5-10S		
	2-2000C	1/4"	18X1,5-12L		
	2-2001.	5/16"	16X1,5-10L		
	2-2001C	5/16"	18X1,5-10S		
	2-2001A	5/16"	18X1,5-12L		
	2-2001B	5/16"	20X1,5-12S		
	2-2002.	3/8"	16X1,5-10L		
	2-2002E	3/8"	18X1,5-10S		
	2-2002A	3/8"	18X1,5-12L		
	2-2002B	3/8"	20X1,5-12S		
	2-2002D	3/8"	22X1,5-14S		
	2-2002C	3/8"	22X1,5-15L		
	2-2003.	1/2"	18X1,5-12L		
	2-2003A	1/2"	20X1,5-12S		
	2-2003B	1/2"	22X1,5-14S		
	2-2003C	1/2"	22X1,5-15L		
	2-2003D	1/2"	24X1,5-16S		
	2-2003E	1/2"	26X1,5-18L		
	2-2004C	5/8"	24X1,5-16S		
	2-2004.	5/8"	26X1,5-18L		
	2-2004A	5/8"	30X2,0-20S		
	2-2004B	5/8"	30X2,0-22L		
	2-2005.	3/4"	26X1,5-18L		
	2-2005A	3/4"	30X2,0-20S		
	2-2005A-S	3/4"	30X2,0-20S		ΣΦΥΡΑΣ
	2-2005B	3/4"	30X2,0-22L		
2-2005C	3/4"	36X2,0-25S			
2-2005C-S	3/4"	36X2,0-25S	ΣΦΥΡΑΣ		
2-2006.	1"	36X2,0-25S			
2-2006A	1"	36X2,0-28L			
2-2006B	1"	42X2,0-30S			
2-2007.	1 1/4"	45X2,0-35L			
2-2007A	1 1/4"	52X2,0-38S			
2-2007B	1 1/4"	52X2,0-42L			
2-2008A	1 1/2"	52X2,0-38S			

ΑΝΟΔΟΣ- ΔΗΜ Ι ΣΟΥΑΝΗΣ

2-ΡΑΚΟΡ ΥΔΡΑΥΛΙΚΗΣ ΠΡΕΣΣΑΣ ΣΠΕΙΡΩΜΑ ΜΕΤΡΙΚΟ

ΚΩΔΙΚΟΣ	ΔΙΑΣ.ΣΩΛΗΝΑ	ΣΠΕΙΡΩΜΑ	
2-2100AA	3/16"	12X1,5-6L	ΑΡΣΕΝΙΚΑ ΡΑΚΟΡ ΜΕΤΡΙΚΑ 24*
2-2100	1/4"	12X1,5-6L	
2-2100D	1/4"	14X1,5-6S	
2-2100A	1/4"	14X1,5-8L	
2-2100E	1/4"	16X1,5-8S	
2-2100B	1/4"	16X1,5-10L	
2-2100F	1/4"	16X1,5-10S	
2-2100C	1/4"	18X1,5-12L	
2-2101	5/16"	16X1,5-10L	
2-2101C	5/16"	18X1,5-10S	
2-2101A	5/16"	18X1,5-12L	
2-2101B	5/16"	20X1,5-12S	
2-2102.	3/8"	16X1,5-10L	
2-2102E	3/8"	18X1,5-10S	
2-2102A	3/8"	18X1,5-12L	
2-2102B	3/8"	20X1,5-12S	
2-2102D	3/8"	22X1,5-14S	
2-2102C	3/8"	22X1,5-15L	
2-2103.	1/2"	18X1,5-12L	
2-2103A	1/2"	20X1,5-12S	
2-2103B	1/2"	22X1,5-14S	
2-2103C	1/2"	22X1,5-15L	
2-2103D	1/2"	24X1,5-16S	
2-2103E	1/2"	26X1,5-18L	
2-2104C	5/8"	24X1,5-16S	
2-2104	5/8"	26X1,5-18L	
2-2104A	5/8"	30X2,0-20S	
2-2104B	5/8"	30X2,0-22L	
2-2105.	3/4"	26X1,5-18L	
2-2105A	3/4"	30X2,0-20S	
2-2105A-S	3/4"	30X2,0-20S	ΣΦΥΡΑΣ
2-2105B	3/4"	30X2,0-22L	
2-2105C	3/4"	36X2,0-25S	
2-2105C-S	3/4"	36X2,0-25S	ΣΦΥΡΑΣ
2-2106	1"	36X2,0-25S	
2-2106A	1"	36X2,0-28L	
2-2106B	1"	42X2,0-30S	
2-2107	1 1/4"	45X2,0-35L	
2-2107A	1 1/4"	52X2,0-38S	
2-2107B	1 1/4"	52X2,0-42L	
2-2108A	1 1/2"	52X2,0-38S	



ΑΝΟΔΟΣ- ΔΗΜ Ι ΣΟΥΑΝΗΣ

2-ΡΑΚΟΡ ΥΔΡΑΥΛΙΚΗΣ ΠΡΕΣΣΑΣ ΣΠΕΙΡΩΜΑ ΜΕΤΡΙΚΟ

ΚΩΔΙΚΟΣ	ΔΙΑΣ.ΣΩΛΗΝΑ	ΣΠΕΙΡΩΜΑ		
	2-2200AA	3/16"	12X1,5-6L	
	2-2200	1/4"	12X1,5-6L	
	2-2200D	1/4"	14X1,5-6S	
	2-2200A	1/4"	14X1,5-8L	
	2-2200E	1/4"	16X1,5-8S	
	2-2200B	1/4"	16X1,5-10L	
	2-2200F	1/4"	16X1,5-10S	
	2-2200C	1/4"	18X1,5-12L	
	2-2201	5/16"	16X1,5-10L	
	2-2201C	5/16"	18X1,5-10S	
	2-2201A	5/16"	18X1,5-12L	
	2-2201B	5/16"	20X1,5-12S	
	2-2202.	3/8"	16X1,5-10L	
	2-2202E	3/8"	18X1,5-10S	
	2-2202A	3/8"	18X1,5-12L	
	2-2202B	3/8"	20X1,5-12S	
	2-2202D	3/8"	22X1,5-14S	
	2-2202C	3/8"	22X1,5-15L	
	2-2203.	1/2"	18X1,5-12L	
	2-2203A	1/2"	20X1,5-12S	
	2-2203B	1/2"	22X1,5-14S	
	2-2203C	1/2"	22X1,5-15L	
	2-2203D	1/2"	24X1,5-16S	
	2-2203E	1/2"	26X1,5-18L	
	2-2204C	5/8"	24X1,5-16S	
	2-2204	5/8"	26X1,5-18L	
	2-2204A	5/8"	30X2,0-20S	
	2-2204B	5/8"	30X2,0-22L	
	2-2205.	3/4"	18X1,5-18L	
	2-2205A	3/4"	30X2,0-20S	
	2-2205A-S	3/4"	30X2,0-20S	ΣΦΥΡΑΣ
	2-2205B	3/4"	30X2,0-22L	
	2-2205C	3/4"	36X2,0-25S	
	2-2205C-S	3/4"	36X2,0-25S	ΣΦΥΡΑΣ
	2-2206	1"	36X2,0-25S	
	2-2206A	1"	36X2,0-28L	
	2-2206B	1"	42X2,0-30S	
	2-2207	1 1/4"	45X2,0-35L	
	2-2207A	1 1/4"	52X2,0-38S	
	2-2207B	1 1/4"	52X2,0-42L	
	2-2208A	1 1/2"	52X2,0-38S	

ΓΩΝΙΑ 90*
ΜΕΤΡΙΚΑ
24*-60*

ΑΝΟΔΟΣ- ΔΗΜ Ι ΣΟΥΑΝΗΣ

2-ΡΑΚΟΡ ΥΔΡΑΥΛΙΚΗΣ ΠΡΕΣΣΑΣ ΣΠΕΙΡΩΜΑ ΜΕΤΡΙΚΟ

ΚΩΔΙΚΟΣ	ΔΙΑΣ.ΣΩΛΗΝΑ	ΣΠΕΙΡΩΜΑ	
2-2300AA	3/16"	12X1,5-6L	ΓΩΝΙΑ 45*
2-2300	1/4"	12X1,5-6L	
2-2300D	1/4"	14X1,5-6S	ΜΕΤΡΙΚΑ
2-2300A	1/4"	14X1,5-8L	
2-2300E	1/4"	16X1,5-8S	24*
2-2300B	1/4"	16X1,5-10L	
2-2300F	1/4"	16X1,5-10S	
2-2300C	1/4"	18X1,5-12L	
2-2301	5/16"	16X1,5-10L	
2-2301C	5/16"	18X1,5-10S	
2-2301A	5/16"	18X1,5-12L	
2-2301B	5/16"	20X1,5-12S	
2-2302.	3/8"	16X1,5-10L	
2-2302E	3/8"	18X1,5-10S	
2-2302A	3/8"	18X1,5-12L	
2-2302B	3/8"	20X1,5-12S	
2-2302D	3/8"	22X1,5-14S	
2-2302C	3/8"	22X1,5-15L	
2-2303.	1/2"	18X1,5-12L	
2-2303A	1/2"	20X1,5-12S	
2-2303B	1/2"	22X1,5-14S	
2-2303C	1/2"	22X1,5-15L	
2-2303D	1/2"	24X1,5-16S	
2-2303E	1/2"	26X1,5-18L	
2-2304C	5/8"	24X1,5-16S	
2-2304	5/8"	26X1,5-18L	
2-2304A	5/8"	30X2,0-20S	
2-2304B	5/8"	30X2,0-22L	
2-2305	3/4"	30X2,0-20S	
2-2305-S	3/4"	30X2,0-20S	ΣΦΥΡΑΣ
2-2305A	3/4"	30X2,0-22L	
2-2305B	3/4"	36X2,0-25S	
2-2305B-S	3/4"	36X2,0-25S	ΣΦΥΡΑΣ
2-2306	1"	36X2,0-25S	
2-2306A	1"	36X2,0-28L	
2-2306B	1"	42X2,0-30S	
2-2307	1 1/4"	45X2,0-35L	
2-2307A	1 1/4"	52X2,0-38S	
2-2307B	1 1/4"	52X2,0-42L	
2-2308A	1 1/2"	52X2,0-38S	



ΑΝΟΔΟΣ- ΔΗΜ Ι ΣΟΥΑΝΗΣ

2-ΡΑΚΟΡ ΥΔΡΑΥΛΙΚΗΣ ΠΡΕΣΣΑΣ ΣΠΕΙΡΩΜΑ ΜΕΤΡΙΚΟ

	ΚΩΔΙΚΟΣ	ΔΙΑΣ.ΣΩΛΗΝΑ	ΣΠΕΙΡΩΜΑ	
	2-5000A	1/4"	14X1,5	ΡΑΚΟΡ COMMATSU (ΘΗΛΥΚΗ ΦΡΕΖΑ)
	2-5000.	1/4"	16X1,5	
	2-5001.	5/16"	16X1,5	
	2-5002	3/8"	18X1,5	
	2-5003	1/2"	22X1,5	
	2-5004	5/8"	24X1,5	
	2-5005	3/4"	30X1,5	
	2-5006	1"	33X1,3	

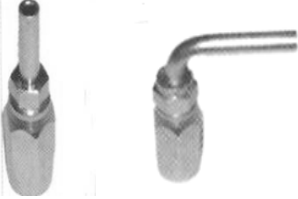

	2-5100A	1/4"	14X1,5	ΡΑΚΟΡ COMMATSU (ΑΡΣ ΦΡΕΖΑ)
	2-5100.	1/4"	16X1,5	
	2-5101.	5/16"	16X1,5	
	2-5102.	3/8"	18X1,5	
	2-5103.	1/2"	22X1,5	
	2-5104.	5/8"	24X1,5	
	2-5105.	3/4"	30X1,5	
	2-5106.	1"	33X1,3	

ΣΩΛΗΝΑΣ-ΡΑΚΟΡ ΚΟΥΒΟΥΚΛΙΟΥ

	1-0190AB	5/32"	200	ΣΩΛΗΝΑΣ ΡΑΚΟΡ ΚΟΥΒΟΥΚΛΙΟΥ
	2-0190AB	5/32"	6L-6LL ΙΣΙΟ	
	2-01900AB	5/32"	6L-6LL 90	
	KY-0190AB	5/32"	ΒΙΔΩΤΟ ΚΥΑΘΕΙΟ	

ΑΝΟΔΟΣ- ΔΗΜ Ι ΣΟΥΑΝΗΣ

2-ΡΑΚΟΡ ΥΔΡΑΥΛΙΚΗΣ ΠΡΕΣΣΑΣ ΣΠΕΙΡΩΜΑ ΙΝΤΣΑΣ UNF 74* (ΑΜΕΡΙΚΗΣ)

	ΚΩΔΙΚΟΣ	ΔΙΑΣ.ΣΩΛΗΝΑ	ΣΠΕΙΡΩΜΑ			
	2-3000	1/4"	7/16"X20	ΘΗΛΥΚΑ ΙΝΤΣΑΣ UNF 74*		
	2-3000A	1/4"	1/2"X20			
	2-3000B	1/4"	9/16"X18			
	2-3001.	5/16"	1/2"X20			
	2-3001A	5/16"	9/16"X18			
	2-3001B	5/16"	5/8"X18			
	2-3001C	5/16"	3/4"X16			
	2-3002	3/8"	9/16"X18			
	2-3002A	3/8"	5/8"X18			
	2-3002B	3/8"	3/4"X16			
	2-3002C	3/8"	7/8"X14			
	2-3003	1/2"	3/4"X16			
	2-3003A	1/2"	7/8"X14			
	2-3004	5/8"	7/8"X14			
	2-3004A	5/8"	1 1/16"X12			
	2-3005	3/4"	1 1/16"X12			
	2-3005A	3/4"	1 3/16"X12			
	2-3005B	3/4"	1 5/16"X12			
	2-3006	1"	1 3/16"X12			
	2-3006A	1"	1 5/16"X12			
	2-3006B	1"	1 5/8"X12			
	2-3007	1 1/4"	1 5/8"X12			
	2-3008	1 1/2"	1 7/8"X12			
		2-3100	1/4"		7/16"X20	ΑΡΣΕΝΙΚΑ ΙΝΤΣΑΣ UNF 74*
		2-3100A	1/4"		1/2"X20	
		2-3100B	1/4"		9/16"X18	
		2-3101D	5/16"		1/2"X20	
		2-3101A	5/16"		9/16"X18	
2-3101B		5/16"	5/8"X18			
2-3101C		5/16"	3/4"X16			
2-3102		3/8"	9/16"X18			
2-3102A		3/8"	5/8"X18			
2-3102B		3/8"	3/4"X16			
2-3103C		3/8"	7/8"X14			
2-3103		1/2"	3/4"X16			
2-3103A		1/2"	7/8"X14			
2-3104		5/8"	7/8"X14			
2-3104A		5/8"	1 1/16"X12			
2-3105		3/4"	1 1/16"X12			
2-3105A		3/4"	1 3/16"X12			
2-3105B		3/4"	1 5/16"X12			
2-3106		1"	1 3/16"X12			
2-3106A		1"	1 5/16"X12			
2-3106B		1"	1 5/8"X12			
2-3107		1 1/4"	1 5/8"X12			
2-3108		1 1/2"	1 7/8"X12			

ΑΝΟΔΟΣ- ΔΗΜ Ι ΣΟΥΑΝΗΣ

2-ΡΑΚΟΡ ΥΔΡΑΥΛΙΚΗΣ ΠΡΕΣΣΑΣ ΣΠΕΙΡΩΜΑ ΙΝΤΣΑΣ UNF 74* (ΑΜΕΡΙΚΗΣ)

	ΚΩΔΙΚΟΣ	ΔΙΑΣ.ΣΩΛΗΝΑ	ΣΠΕΙΡΩΜΑ	
	2-3200	1/4"	7/16"X20	ΓΩΝΙΕΣ 90* ΙΝΤΣΑΣ UNF 74*
	2-3200A	1/4"	1/2"X20	
	2-3200B	1/4"	9/16"X18	
	2-3201.	5/16"	1/2"X20	
	2-3201A	5/16"	9/16"X18	
	2-3201B	5/16"	5/8"X18	
	2-3201C	5/16"	3/4"X16	
	2-3202	3/8"	9/16"X18	
	2-3202A	3/8"	5/8"X18	
	2-3202B	3/8"	3/4"X16	
	2-3202C	3/8"	7/8"X14	
	2-3203	1/2"	3/4"X16	
	2-3203A	1/2"	7/8"X14	
	2-3204	5/8"	7/8"X14	
	2-3204A	5/8"	1 1/16"X12	
	2-3205	3/4"	1 1/16"X12	
	2-3205A	3/4"	1 3/16"X12	
	2-3205B	3/4"	1 5/16"X12	
	2-3206	1"	1 3/16"X12	
	2-3206A	1"	1 5/16"X12	
2-3206B	1"	1 5/8"X12		
2-3207	1 1/4"	1 5/8"X12		
2-3208	1 1/2"	1 7/8"X12		

	ΚΩΔΙΚΟΣ	ΔΙΑΣ.ΣΩΛΗΝΑ	ΣΠΕΙΡΩΜΑ	
	2-3300	1/4"	7/16"X20	ΓΩΝΙΕΣ 45* ΙΝΤΣΑΣ UNF 74*
	2-3300A	1/4"	1/2"X20	
	2-3300B	1/4"	9/16"X18	
	2-3301A	5/16"	9/16"X18	
	2-3301B	5/16"	5/8"X18	
	2-3302	3/8"	9/16"X18	
	2-3302A	3/8"	5/8"X18	
	2-3302B	3/8"	3/4"X16	
	2-3303	1/2"	3/4"X16	
	2-3303A	1/2"	7/8"X14	
	2-3304	5/8"	7/8"X14	
	2-3304A	5/8"	1 1/16"X12	
	2-3305	3/4"	1 1/16"X12	
	2-3305A	3/4"	1 3/16"X12	
	2-3305B	3/4"	1 5/16"X12	
	2-3306	1"	1 3/16"X12	
	2-3306A	1"	1 5/16"X12	
	2-3306B	1"	1 5/8"X12	
	2-3307	1 1/4"	1 5/8"X12	
	2-3308	1 1/2"	1 7/8"X12	

ΑΝΟΔΟΣ- ΔΗΜΙΣΟΥΑΝΗΣ





2-ΡΑΚΟΡ ΥΔΡΑΥΛΙΚΗΣ ΠΡΕΣΣΑΣ ΓΙΑ ΠΕΡΑΣΤΟ ΠΑΞΙΜΑΔΙ RZ

	ΚΩΔΙΚΟΣ	ΔΙΑΣ.ΣΩΛΗΝΑ	Φ	
	2-4000	1/4"	6L-S	ΙΣΙΟ
	2-4000A	1/4"	8L-S	
	2-4000B	1/4"	10L-S	
	2-4001B	5/16"	8L-S	
	2-4001	5/16"	10L-S	
	2-4001A	5/16"	12L-S	
	2-4002B	3/8"	10L-S	
	2-4002	3/8"	12L-S	
	2-4002A	3/8"	14S	
	2-4002C	3/8"	15L	
	2-4003B	1/2"	14S	
	2-4003C	1/2"	15L	
	2-4003D	1/2"	16S	
	2-4003E	1/2"	18L	
	2-4004B	5/8"	16S	
	2-4004	5/8"	18L	
	2-4004A	5/8"	20S	
	2-4005	3/4"	20S	
	2-4005A	3/4"	22L	
	2-4005B	3/4"	25S	
	2-4006	1"	25S	
	2-4006A	1"	28L	
	2-4006B	1"	30S	

	ΚΩΔΙΚΟΣ	ΔΙΑΣ.ΣΩΛΗΝΑ	Φ	
	2-4200	1/4"	6L-S	ΓΩΝΙΑ 90*
	2-4200A	1/4"	8L-S	
	2-4200B	1/4"	10L-S	
	2-4201B	5/16"	8L-S	
	2-4201	5/16"	10L-S	
	2-4201A	5/16"	12L-S	
	2-4202C	3/8"	10L-S	
	2-4202	3/8"	12L-S	
	2-4202A	3/8"	14S	
	2-4202B	3/8"	15L	
	2-4203B	1/2"	14S	
	2-4203C	1/2"	15L	
	2-4203D	1/2"	16S	
	2-4203E	1/2"	18L	
	2-4204B	5/8"	16S	
	2-4204.	5/8"	18L	
	2-4204A	5/8"	20S	
	2-4205.	3/4"	20S	
	2-4205A	3/4"	22L	
	2-4205B	3/4"	25S	
	2-4206.	1"	25S	
	2-4206A	1"	28L	
	2-4206B	1"	30S	

ΑΝΟΔΟΣ- ΔΗΜ Ι ΣΟΥΑΝΗΣ

2-ΡΑΚΟΡ ΥΔΡΑΥΛΙΚΗΣ ΠΡΕΣΣΑΣ Ο.Ρ.Φ.Σ

	ΚΩΔΙΚΟΣ	ΔΙΑΣ.ΣΩΛΗΝΑ	ΣΠΕΙΡΩΜΑ	
	2-7000	1/4"	9/16"X18	Ο.Ρ.Φ.Σ ΘΗΛΥΚΟ
	2-7000A	1/4"	11/16"X16	
	2-7001.	5/16"	11/16"X16	
	2-7002	3/8"	11/16"X16	
	2-7002A	3/8"	13/16"X16	
	2-7003	1/2"	13/16"X16	
	2-7003A	1/2"	1"X14	
	2-7004	5/8"	1"X14	
	2-7004A	5/8"	1 3/16"X12	
	2-7005	3/4"	1 3/16"X12	
	2-7005A	3/4"	1 7/16"X12	
	2-7006	1"	1 7/16"X12	
	2-7007	1 1/4"	1 11/16"X12	
		2-7100.	1/4"	
2-7100A		1/4"	11/16"X16	
2-7101.		5/16"	11/16"X16	
2-7102		3/8"	11/16"X16	
2-71002A		3/8"	13/16"X16	
2-7103		1/2"	13/16"X16	
2-7103A		1/2"	1"X14	
2-7104.		5/8"	1"X14	
2-7104A		5/8"	1 3/16"X12	
2-7105		3/4"	1 3/16"X12	
2-7105A		3/4"	1 7/16"X12	
2-7106		1"	1 7/16"X12	
2-7107.		1 1/4"	1 11/16"X12	
		2-7200	1/4"	9/16"X18
	2-7200A	1/4"	11/16"X16	
	2-7201.	5/16"	11/16"X16	
	2-7202	3/8"	11/16"X16	
	2-7202A	3/8"	13/16"X16	
	2-7203	1/2"	13/16"X16	
	2-7203A	1/2"	1"X14	
	2-7204	5/8"	1"X14	
	2-7204A	5/8"	1 3/16"X12	
	2-7205	3/4"	1 3/16"X12	
	2-7205A	3/4"	1 7/16"X12	
	2-7206	1"	1 7/16"X12	
	2-7207	1 1/4"	1 11/16"X12	
		2-7300	1/4"	9/16"X18
2-7300A		1/4"	11/16"X16	
2-7301.		5/16"	11/16"X16	
2-7302		3/8"	11/16"X16	
2-7302A		3/8"	13/16"X16	
2-7303		1/2"	13/16"X16	
2-7303A		1/2"	1"X14	
2-7304		5/8"	1"X14	
2-7305		3/4"	1 3/16"X12	
2-7306		1"	1 7/16"X12	
2-7307		1 1/4"	1 11/16"X12	

ΑΝΟΔΟΣ- ΔΗΜ Ι ΣΟΥΑΝΗΣ

2-ΡΑΚΟΡ ΡΑΝΙΟ ΥΔΡΑΥΛΙΚΗΣ ΠΡΕΣΣΑΣ (ΘΗΛΕΙΑ)

	ΚΩΔΙΚΟΣ	ΔΙΑΣ.ΣΩΛΗΝΑ	ΘΗΛΕΙΑ	
	2-6000AA	3/16"	1/4"	ΘΗΛΕΙΑ ΙΝΤΣΑΣ
	2-6000	1/4"	1/4"	
	2-6000A	1/4"	3/8"	
	2-6001A	5/16"	1/4"	
	2-6001	5/16"	3/8"	
	2-6002	3/8"	3/8"	
	2-6002A	3/8"	1/2"	
	2-6003	1/2"	3/8"	
	2-6003A	1/2"	1/2"	
	2-6004.	5/8"	5/8"	
	2-6005	3/4"	3/4"	
	2-6006	1"	1"	

	ΚΩΔΙΚΟΣ	ΔΙΑΣ.ΣΩΛΗΝΑ	ΘΗΛΕΙΑ	
	2-6010AA	1/4"	10MM	ΘΗΛΕΙΑ ΜΕΤΡΙΚΗ
	2-6010	1/4"	12MM	
	2-6010A	1/4"	14MM	
	2-6011	5/16"	12MM	
	2-6011A	5/16"	14MM	
	2-6011B	5/16"	16MM	
	2-6011C	5/16"	18MM	
	2-6012	3/8"	14MM	
	2-6012A	3/8"	16MM	
	2-6012B	3/8"	18MM	
	2-6012C	3/8"	20MM	
	2-6013	1/2"	18MM	
	2-6013A	1/2"	20MM	
	2-6013B	1/2"	22MM	
	2-6014	5/8"	22MM	
	2-6014A	5/8"	26MM	
	2-6015	3/4"	26MM	
2-6015A	3/4"	30MM		
2-6016	1"	30MM		

ΑΝΟΔΟΣ- ΔΗΜ Ι ΣΟΥΑΝΗΣ

2-ΠΑΚΟΡ FREON (AIRCONDITION)

	ΚΩΔΙΚΟΣ	ΔΙΑΣ.ΣΩΛΗΝΑ	ΣΠΕΙΡΩΜΑ	
	2-F-01	5/16"	5/8"X18	ΙΣΙΟ Ο'RING
	2-F-02	13/32"	3/4"X16	
	2-F-03	1/2"	7/8"X14	
	2-F-04	5/8"	7/8"X14	
	2-F-04A	5/8"	1 1/16"X12	
	2-F-05	7/8"	1 1/16"X12	
	2-F-11	5/16"	5/8"X18	ΓΩΝΙΑ 90* Ο'RING
	2-F-12	13/32"	3/4"X16	
	2-F-13	1/2"	7/8"X14	
	2-F-14	5/8"	7/8"X14	
	2-F-14A	5/8"	1 1/16"X12	
	2-F-015	7/8"	1 1/16"X12	
	2-F-21	5/16"	5/8"X18	ΓΩΝΙΑ 45* Ο'RING
	2-F-22	13/32"	3/4"X16	
	2-F-23	1/2"	7/8"X14	
	2-F-24	5/8"	7/8"X14	
	2-F-24A	5/8"	1 1/16"X12	
	2-F-25	7/8"	1 1/16"X12	
	2-F-011	5/16"	5/8"X18	ΙΣΙΟ ΚΩΝΟΣ 74*
	2-F-012	13/32"	3/4"X16	
	2-F-013	1/2"	7/8"X14	
	2-F-014	5/8"	1 1/16"X12	
	2-F-111	5/16"	5/8"X18	ΓΩΝΙΑ 90* ΚΩΝΟΣ 74*
	2-F-112	13/32"	3/4"X16	
	2-F-113	1/2"	7/8"X14	
	2-F-114	5/8"	1 1/16"X12	
	2-F-121	5/16"	5/8"X18	ΓΩΝΙΑ 45* ΚΩΝΟΣ 74*
	2-F-122	13/32"	3/4"X16	
	2-F-123	1/2"	7/8"X14	
	2-F-124	5/8"	1 1/16"X12	

ΑΝΟΔΟΣ- ΔΗΜΙΣΟΥΑΝΗΣ

2-ΡΑΚΟΡ ΥΔΡΑΥΛΙΚΗΣ ΠΡΕΣΣΑΣ ΦΛΑΝΤΖΩΤΑ J518-6000PSI

	ΚΩΔΙΚΟΣ	ΔΙΑΣ.ΣΩΛΗΝΑ	ΦΛΑΝΤΖΑ	
	2-8003	1/2"	31,7x8	ΡΑΚΟΡ ΦΛΑΝΤΖΩΤΑ ΙΣΙΑ 6000PSI
	2-8003A	1/2"	41,3x9,5	
	2-8004.	5/8"	41,3x9,5	
	2-8005	3/4"	41,3x9,5	
	2-8005A	3/4"	47,6x9,5	
	2-8006A	1"	41,3x9,5	
	2-8006	1"	47,6x9,5	
	2-8006B	1"	54,0x10,3	
	2-8007	1 1/4"	54,0x10,3	
	2-8007A	1 1/4"	63,5x12,7	
2-8008	1 1/2"	63,5x12,7		

	2-8203	1/2"	31,7x8	ΡΑΚΟΡ ΦΛΑΝΤΖΩΤΑ 90* 6000PSI
	2-8203A	1/2"	41,3x9,5	
	2-8204.	5/8"	41,3x9,5	
	2-8205	3/4"	41,3x9,5	
	2-8205A	3/4"	47,6x9,5	
	2-8206A	1"	41,3x9,5	
	2-8206	1"	47,6x9,5	
	2-8206B	1"	54,0x10,3	
	2-8207	1 1/4"	54,0x10,3	
	2-8207A	1 1/4"	63,5x12,7	
2-8208	1 1/2"	63,5x12,7		

	2-8303	1/2"	31,7x8	ΡΑΚΟΡ ΦΛΑΝΤΖΩΤΑ 45* 6000PSI
	2-8303A	1/2"	41,3x9,5	
	2-8304.	5/8"	41,3x9,5	
	2-8305	3/4"	41,3x9,5	
	2-8305A	3/4"	47,6x9,5	
	2-8306A	1"	41,3x9,5	
	2-8306	1"	47,6x9,5	
	2-8306B	1"	54,0x10,3	
	2-8307	1 1/4"	54,0x10,3	
	2-8307A	1 1/4"	63,5x12,7	
2-8308	1 1/2"	63,5x12,7		

	K-8-03		Φ31,7	ΚΟΥΖΙΝΕΤΑ 6000 PSI
	K-8-05		Φ41,3	
	K-8-06		Φ47,6	
	K-8-07		Φ54	
	K-8-08		Φ63,5	

ΑΝΟΔΟΣ- ΔΗΜ Ι ΣΟΥΑΝΗΣ

2-ΡΑΚΟΡ ΥΔΡΑΥΛΙΚΗΣ ΠΡΕΣΣΑΣ ΦΛΑΝΤΖΩΤΑ J518-6000PSI





	ΚΩΔΙΚΟΣ	ΔΙΑΣ.ΣΩΛΗΝΑ	ΦΛΑΝΤΖΑ	
	2-8327.	1 1/4"	54,0x10,3	ΡΑΚΟΡ ΦΛΑΝΤΖΩΤΑ 30* 6000PSI
	2-8327A	1 1/4"	63,5x12,7	
	2-8337.	1 1/4"	54,0x10,3	ΡΑΚΟΡ ΦΛΑΝΤΖΩΤΑ 22* 6000PSI
	2-8337A	1 1/4"	63,5x12,7	

	2-82004	5/8"	41,3x9,5	ΡΑΚΟΡ ΦΛΑΝΤΖΩΤΑ 90* 6000PSI
	2-82005	3/4"	41,3x9,5	
	2-82005A	3/4"	47,6x9,5	ΥΠΕΡΜΑΚΡΥ ΣΤΕΛΕΧΟΣ
	2-82006	1"	47,6x9,5	
	2-82006B	1"	54,0x10,3	
	2-82007	1 1/4"	54,0x10,3	
	2-82007A	1 1/4"	63,5x12,7	
	2-82008	1 1/2"	63,5x12,7	

	2-83004	5/8"	41,3x9,5	ΡΑΚΟΡ ΦΛΑΝΤΖΩΤΑ 45* 6000PSI
	2-83005	3/4"	41,3x9,5	
	2-83005A	3/4"	47,6x9,5	ΥΠΕΡΜΑΚΡΥ ΣΤΕΛΕΧΟΣ
	2-83006	1"	47,6x9,5	
	2-83006B	1"	54,0x10,3	
	2-83007	1 1/4"	54,0x10,3	
	2-83007A	1 1/4"	63,5x12,7	
	2-83008	1 1/2"	63,5x12,7	

ΑΝΟΔΟΣ- ΔΗΜΙΣΟΥΑΝΗΣ

2-ΡΑΚΟΡ ΥΔΡΑΥΛΙΚΗΣ ΠΡΕΣΣΑΣ ΦΛΑΝΤΖΩΤΑ J518-3000PSI

	ΚΩΔΙΚΟΣ	ΔΙΑΣ.ΣΩΛΗΝΑ	ΦΛΑΝΤΖΑ	
	2-8013	1/2"	30,2	ΡΑΚΟΡ ΦΛΑΝΤΖΩΤΑ ΙΣΙΑ 3000PSI CATERPILLAR
	2-8013A	1/2"	38,1	
	2-8014A	5/8"	34	
	2-8014.	5/8"	38,1	
	2-8015	3/4"	38,1	
	2-8015A	3/4"	44,5	
	2-8016	1"	44,5	
	2-8016A	1"	50,8	
	2-8017	1 1/4"	50,8	
	2-8017A	1 1/4"	60,3	
	2-8018	1 1/2"	60,3	
2-8018A	1 1/2"	71,4		
2-8019	2"	71,4		
	2-8213	1/2"	30,2	ΡΑΚΟΡ ΦΛΑΝΤΖΩΤΑ 90* 3000PSI CATERPILLAR
	2-8213A	1/2"	38,1	
	2-8214A	5/8"	34	
	2-8214.	5/8"	38,1	
	2-8215	3/4"	38,1	
	2-8215A	3/4"	44,5	
	2-8216	1"	44,5	
	2-8216A	1"	50,8	
	2-8217	1 1/4"	50,8	
	2-8217A	1 1/4"	60,3	
	2-8218	1 1/2"	60,3	
2-8218A	1 1/2"	71,4		
2-8219	2"	71,4		
	2-8313	1/2"	30,2	ΡΑΚΟΡ ΦΛΑΝΤΖΩΤΑ 45* 3000PSI CATERPILLAR
	2-8313A	1/2"	38,1	
	2-8314A	5/8"	34	
	2-8314.	5/8"	38,1	
	2-8315	3/4"	38,1	
	2-8315A	3/4"	44,5	
	2-8316	1"	44,5	
	2-8316A	1"	50,8	
	2-8317	1 1/4"	50,8	
	2-8317A	1 1/4"	60,3	
	2-8318	1 1/2"	60,3	
2-8318A	1 1/2"	71,4		
2-8319	2"	71,4		
	K-8-13		Φ30,2	ΚΟΥΖΙΝΕΤΑ 3000PSI
	K-8-15		Φ38,1	
	K-8-16		Φ44,5	
	K-8-17		Φ50,8	
	K-8-18		Φ60,3	
	K-8-19		Φ71,4	

ΑΝΟΔΟΣ- ΔΗΜΙΣΟΥΑΝΗΣ

2-ΡΑΚΟΡ ΥΔΡΑΥΛΙΚΗΣ ΠΡΕΣΣΑΣ ΦΛΑΝΤΖΩΤΑ J518-3000PSI

	ΚΩΔΙΚΟΣ	ΔΙΑΣ.ΣΩΛΗΝΑ	ΦΛΑΝΤΖΑ	
	2-8345.	3/4"	38,1	ΡΑΚΟΡ ΦΛΑΝΤΖΩΤΑ 60* 3000PSI CATERPILLAR
	2-8346.	1"	44,5	
	2-8346A	1"	50,8	
	2-8347.	1 1/4"	50,8	
	2-8347A	1 1/4"	60,3	
	2-8348.	1 1/2"	60,3	

	2-8355.	3/4"	38,1	ΡΑΚΟΡ ΦΛΑΝΤΖΩΤΑ 30* 3000PSI CATERPILLAR
	2-8356.	1"	44,5	
	2-8356A	1"	50,8	
	2-8357.	1 1/4"	50,8	
	2-8357A	1 1/4"	60,3	
	2-8358.	1 1/2"	60,3	

	2-8365.	3/4"	38,1	ΡΑΚΟΡ ΦΛΑΝΤΖΩΤΑ 22* 3000PSI CATERPILLAR
	2-8366.	1"	44,5	
	2-8366A.	1"	50,8	
	2-8367.	1 1/4"	50,8	
	2-8367A	1 1/4"	60,3	
	2-8368.	1 1/2"	60,3	







	2-82015	3/4"	38,1	ΡΑΚΟΡ ΦΛΑΝΤΖΩΤΑ 90* 3000PSI ΥΠΕΡΜΑΚΡΥ ΣΤΕΛΕΧΟΣ CATERPILLAR
	2-82015A	3/4"	44,5	
	2-82016	1"	44,5	
	2-82016A	1"	50,8	
	2-82017	1 1/4"	50,8	

	2-84016	1"	44,5	ΡΑΚΟΡ ΦΛΑΝΤΖΩΤΑ 120* 3000PSI ΥΠΕΡΜΑΚΡΥ ΣΤΕΛΕΧΟΣ MAC CORMICK
---	---------	----	------	--

	2-84026	1"	44,5	ΡΑΚΟΡ ΦΛΑΝΤΖΩΤΑ 3000 PSI ΥΠΕΡΜΑΚΡΥ ΣΤΕΛΕΧΟΣ ΤΥΠΟΥ S MAC CORMICK
---	---------	----	------	--

ΑΝΟΔΟΣ- ΔΗΜΙΣΟΥΑΝΗΣ

1-ΡΑΚΟΡ ΥΔΡΑΥΛΙΚΗΣ ΠΡΕΣΣΑΣ ΦΛΑΝΤΖΩΤΑ J518-6000PSI

	ΚΩΔΙΚΟΣ	ΔΙΑΣ.ΣΩΛΗΝΑ	ΦΛΑΝΤΖΑ		
	2-8005S	3/4"	41,3X14	ΦΛΑΝΤΖΩΤΑ ΤΥΠΟΥ SUPERCAT ΙΣΙΟ	
	2-8005AS	3/4"	47,6X14		
	2-8006S	1"	47,6X14		
	2-8006AS	1"	54,0X14		
	2-8007S	1 1/4"	54,0X14		
	2-8007AS	1 1/4"	63,5X14		
	2-8008S	1 1/2"	63,5X14		
	2-8205S	3/4"	41,3X14	ΦΛΑΝΤΖΩΤΑ ΤΥΠΟΥ SUPERCAT 90*	
	2-8205AS	3/4"	47,6X14		
	2-8206S	1"	47,6X14		
	2-8206AS	1"	54,0X14		
	2-8207S	1 1/4"	54,0X14		
	2-8207AS	1 1/4"	63,5X14		
	2-8208S	1 1/2"	63,5X14		
	2-8305S	3/4"	41,3X14	ΦΛΑΝΤΖΩΤΑ ΤΥΠΟΥ SUPERCAT 45*	
	2-8305AS	3/4"	47,6X14		
	2-8306S	1"	47,6X14		
	2-8306AS	1"	54,0X14		
	2-8307S	1 1/4"	54,0X14		
	2-8307AS	1 1/4"	63,5X14		
	2-8308S	1 1/2"	63,5X14		
	2-8377S	1 1/4"	54,0X14	ΦΛΑΝΤΖΩΤΑ ΤΥΠΟΥ SUPERCAT 30*	
	2-8377AS	1 1/4"	63,5X14		
	2-8387S	1 1/4"	54,0X14		ΦΛΑΝΤΖΩΤΑ ΤΥΠΟΥ SUPERCAT 22*
	2-8387AS	1 1/4"	63,5X14		
	0-8030-31		30,2-31,8	Ο'RING ΣΤΡΟΓΓΥΛΟ	
	0-8038-41		38,1-41,3		
	0-8044-47		44,5-47,6		
	0-8050-54		50,8-54,0		
	0-8060-63		60,3-63,5		
	0-8141		41,3	Ο'RING CAT ΤΕΤΡΑΓΩΝΟ ΜΑΥΡΟ	
	0-8147		47,6		
	0-8154		54		
	0-8163		63,5		
	0-8241		41,3	Ο'RING CAT ΤΕΤΡΑΓΩΝΟ ΠΡΑΣΙΝΟ	
	0-8247		47,6		
	0-8254		54		
	0-8263		63,5		

ΑΝΟΔΟΣ- ΔΗΜ Ι ΣΟΥΑΝΗΣ

2-ΡΑΚΟΡ ΥΔΡΑΥΛΙΚΗΣ ΠΡΕΣΣΑΣ ΡΟCLAIN ΜΕ ΣΠΕΙΡΩΜΑ & ΦΛΑΝΤΖΩΤΟ

	ΚΩΔΙΚΟΣ	ΔΙΑΣ.ΣΩΛΗΝΑ	ΣΠΕΙΡΩΜΑ	
	2-P-04	5/8"	30X1,5-21,25	ΘΗΛΥΚΑ ΡΟCLAIN
	2-P-04A	5/8"	36X1,5-26,75	
	2-P-05	3/4"	36X1,5-26,75	
	2-P-06A	1"	38X1,5-30,3	
	2-P-06	1"	45X1,5-33,5	
	2-P-14	5/8"	30X1,5-21,25	ΑΡΣΕΝΙΚΑ ΡΟCLAIN
	2-P-14A	5/8"	36X1,5-26,75	
	2-P-15	3/4"	36X1,5-26,75	
	2-P-16A	1"	38X1,5-30,3	
	2-P-16	1"	45X1,5-33,5	
	2-P-24	5/8"	30X1,5-21,25	ΓΩΝΙΑ 90* ΡΟCLAIN
	2-P-24A	5/8"	36X1,5-26,75	
	2-P-25	3/4"	36X1,5-26,75	
	2-P-26A	1"	38X1,5-30,3	
	2-P-26	1"	45X1,5-33,5	
	2-P-8023	1/2"	13	ΡΟCLAIN ΦΛΑΝΤΖΩΤΑ ΑΡΣΕΝΙΚΑ-ΙΣΙΑ
	2-P-8024	5/8"	21	
	2-P-8025	3/4"	27	
	2-P-8026	1"	34	
	2-P-8027	1 1/4"	43	
	2-P-8123	1/2"	13	ΡΟCLAIN ΦΛΑΝΤΖΩΤΑ ΘΗΛΥΚΑ ΙΣΙΑ
	2-P-8124	5/8"	21	
	2-P-8125	3/4"	27	
	2-P-8126	1"	34	
	2-P-8127	1 1/4"	43	
	2-P-8223	1/2"	13	ΡΟCLAIN ΦΛΑΝΤΖΩΤΑ ΑΡΣΕΝΙΚΑ 90*
	2-P-8224	5/8"	21	
	2-P-8225	3/4"	27	
	2-P-8226	1"	34	
	2-P-8227	1 1/4"	43	

ΑΝΟΔΟΣ- ΔΗΜ Ι ΣΟΥΑΝΗΣ

2-ΡΑΚΟΡ ΒΙΔΩΤΑ - ΚΥΑΘΕΙΑ ΒΙΔΩΤΑ

	ΚΩΔΙΚΟΣ	ΔΙΑΣ.ΣΩΛΗΝΑ	ΣΠΕΙΡΩΜΑ
	2-1000Α-ΒΙ	1/4"	1/4"
	2-1001Α-ΒΙ	5/16"	3/8"
	2-1002Α-ΒΙ	3/8"	3/8"
	2-1003Α-ΒΙ	1/2"	1/2"
	2-1004-ΒΙ	5/8"	5/8"
	2-1005Α-ΒΙ	3/4"	3/4"
	2-1006Α-ΒΙ	1"	1"

	ΚΩΔΙΚΟΣ	ΔΙΑΣ.ΣΩΛΗΝΑ
	KY-2-0-ΒΙ	1/4"
	KY-2-1-ΒΙ	5/16"
	KY-2-2-ΒΙ	3/8"
	KY-2-3-ΒΙ	1/2"
	KY-2-4-ΒΙ	5/8"
	KY-2-5-ΒΙ	3/4"
	KY-2-6-ΒΙ	1"





ΟΥΡΕΣ ΓΙΑ ΚΟΛΛΗΜΑ-ΟΥΡΕΣ ΣΥΝΔΕΣΗΣ ΔΙΠΛΕΣ

	ΚΩΔΙΚΟΣ	ΔΙΑΣ.ΣΩΛΗΝΑ	ΟΥΡΕΣ ΓΙΑ ΚΟΛΛΗΜΑ
	2-9000	1/4"	
	2-9001	5/16"	
	2-9002	3/8"	
	2-9003	1/2"	
	2-9004	5/8"	
	2-9005	3/4"	
	2-9006	1"	
	2-9007	1 1/4"	
	2-9008	1 1/2"	
	2-9009	2"	
2-9009Α	2 3/8"		

	ΚΩΔΙΚΟΣ	ΔΙΑΣ.ΣΩΛΗΝΑ	ΟΥΡΕΣ ΣΥΝΔΕΣΗΣ ΔΙΠΛΕΣ
	2-9100	1/4"	
	2-9101	5/16"	
	2-9102	3/8"	
	2-9103	1/2"	
	2-9104	5/8"	
	2-9105	3/4"	
	2-9106	1"	
	2-9107	1 1/4"	
	2-9108	1 1/2"	
	2-9109	2"	

ΑΝΟΔΟΣ- ΔΗΜ Ι ΣΟΥΑΝΗΣ

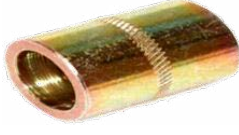
ΚΥ-ΚΥΑΘΕΙΑ ΥΔΡΑΥΛΙΚΗΣ ΠΡΕΣΣΑΣ-ΚΥΑΘΕΙΑ ΧΕΙΡΟΠΡΕΣΣΑΣ

	ΚΩΔΙΚΟΣ	ΔΙΑΣΤΑΣΗ	R(ΠΛΕΓΜΑΤΑ)	
	KY-1-0A	3/16"	R1	SAE 100 R1AT
	KY-1-0	1/4"	R1	
	KY-1-1	5/16"	R1	
	KY-1-2	3/8"	R1	
	KY-1-3	1/2"	R1	
	KY-1-4	5/8"	R1	
	KY-1-5	3/4"	R1	
	KY-1-6	1"	R1	
	KY-1-7	1 1/4"	R1	
	KY-1-8	1 1/2"	R1	
KY-1-9	2"	R1		
	KY-2-0	1/4"	R2	SAE 100 R2AT
	KY-2-1	5/16"	R2	
	KY-2-2	3/8"	R2	
	KY-2-3	1/2"	R2	
	KY-2-4	5/8"	R2	
	KY-2-5	3/4"	R2	
	KY-2-6	1"	R2	
	KY-2-7	1 1/4"	R2	
	KY-2-8	1 1/2"	R2	
	KY-2-9	2"	R2	
	KY-4-2	3/8"	R9-4SP	SAE 100 4SP SAE 100 4SH
	KY-4-3	1/2"	R9-4SP	
	KY-4-4	5/8"	R9-4SP	
	KY-4M-4	5/8"	R9-4SPΜΑΚΡΥ	
	KY-4-5	3/4"	4SH	
	KY-4M-5	3/4"	4SH ΜΑΚΡΥ	
	KY-4-6	1"	4SH	
	KY-4M-6	1"	4SH ΜΑΚΡΥ	
	KY-4-7	1 1/4"	4SH	
	KY-4-8	1 1/2"	4SH	
KY-4-9	2"	4SH		
	KY-7-8-0A	3/16"	R7-R8	SAE 100 R7 - R8
	KY-7-8-0	1/4"	R7-R8	
	KY-7-8-1	5/16"	R7-R8	
	KY-7-8-2	3/8"	R7-R8	
	KY-7-8-3	1/2"	R7-R8	
	KY-7-8-4	5/8"	R7-R8	
	KY-7-8-5	3/4"	R7-R8	
	KY-X-10	10	ΧΕΙΡΟΠΡΕΣΣΑΣ	ΚΥΑΘΕΙΑ ΧΕΙΡΟΠΡΕΣΣΑΣ
	KY-X-12	12	ΧΕΙΡΟΠΡΕΣΣΑΣ	
	KY-X-14	14	ΧΕΙΡΟΠΡΕΣΣΑΣ	
	KY-X-15	15	ΧΕΙΡΟΠΡΕΣΣΑΣ	
	KY-X-16	16	ΧΕΙΡΟΠΡΕΣΣΑΣ	
	KY-X-18	18	ΧΕΙΡΟΠΡΕΣΣΑΣ	
	KY-X-20	20	ΧΕΙΡΟΠΡΕΣΣΑΣ	
	KY-X-22	22	ΧΕΙΡΟΠΡΕΣΣΑΣ	
	KY-X-24	24	ΧΕΙΡΟΠΡΕΣΣΑΣ	
	KY-X-26	26	ΧΕΙΡΟΠΡΕΣΣΑΣ	
KY-X-28	28	ΧΕΙΡΟΠΡΕΣΣΑΣ		

ΑΝΟΔΟΣ- ΔΗΜ Ι ΣΟΥΑΝΗΣ

3-ΝΙΠΕΛ ΣΠΕΙΡΩΜΑ ΙΝΤΣΑΣ

	ΚΩΔΙΚΟΣ	ΣΠΕΙΡΩΜΑ	ΝΙΠΕΛ ΙΝΤΣΑΣ ΙΣΙΟ BSP
	3-1-000A	1/8"	
3-1-000	1/4"		
3-1-002	3/8"		
3-1-003	1/2"		
3-1-004	5/8"		
3-1-005	3/4"		
3-1-006	1"		
3-1-007	1 1/4"		
3-1-008	1 1/2"		
3-1-009	2"		

	ΚΩΔΙΚΟΣ	ΣΠΕΙΡΩΜΑ	ΝΙΠΕΛ ΠΙΝΑΚΟΣ ΙΝΤΣΑΣ ΙΣΙΟ BSP
	3-1-100A	1/8"	
3-1-100	1/4"		
3-1-102	3/8"		
3-1-103	1/2"		
3-1-104	5/8"		
3-1-105	3/4"		
3-1-106	1"		
3-1-107	1 1/4"		
3-1-108	1 1/2"		
3-1-109	2"		

	ΚΩΔΙΚΟΣ	ΣΠΕΙΡΩΜΑ	ΣΠΕΙΡΩΜΑ	ΝΙΠΕΛ ΙΝΤΣΑΣ ΣΥΣΤΟΛΙΚΟ BSP
	3-1-0000	1/8"	1/4"	
3-1-0002	1/4"	3/8"		
3-1-0003	1/4"	1/2"		
3-1-0023	3/8"	1/2"		
3-1-0025	3/8"	3/4"		
3-1-0034	1/2"	5/8"		
3-1-0035	1/2"	3/4"		
3-1-0036	1/2"	1"		
3-1-0045	5/8"	3/4"		
3-1-0056	3/4"	1"		
3-1-0057	3/4"	1 1/4"		
3-1-0067	1"	1 1/4"		
3-1-0078	1 1/4"	1 1/2"		
3-1-0089	1 1/2"	2"		

	ΚΩΔΙΚΟΣ	ΣΠΕΙΡΩΜΑ	ΣΠΕΙΡΩΜΑ	ΝΙΠΕΛ ΙΝΤΣΑΣ ΙΣΙΟ BSP-BSPT
	3-1-110A	1/8"	1/8"BSPT	
3-1-110	1/4"	1/4"BSPT		
3-1-112	3/8"	3/8"BSPT		
3-1-113	1/2"	1/2"BSPT		
3-1-115	3/4"	3/4"BSPT		
3-1-116	1"	1"BSPT		
3-1-117	1 1/4"	1 1/4"BSPT		
3-1-118	1 1/2"	1 1/2"BSPT		
3-1-119	2"	2"BSPT		

ΑΝΟΔΟΣ- ΔΗΜ Ι ΣΟΥΑΝΗΣ

3-ΝΙΠΕΛ ΣΠΕΙΡΩΜΑ ΙΝΤΣΑΣ

	ΚΩΔΙΚΟΣ	ΣΠΕΙΡΩΜΑ	
	3-1-010A	1/8"	ΝΙΠΕΛ ΙΝΤΣΑΣ ΑΡΣΕΝΙΚΟ-ΘΗΛΥΚΟ
	3-1-010	1/4"	
	3-1-012	3/8"	
	3-1-013	1/2"	
	3-1-015	3/4"	
	3-1-016	1"	
	3-1-017	1 1/4"	
	3-1-018	1 1/2"	
	3-1-019	2"	







	3-1-0100A	1/8"	ΝΙΠΕΛ ΙΝΤΣΑΣ ΘΗΛΥΚΟ-ΘΗΛΥΚΟ
	3-1-0100	1/4"	
	3-1-0102	3/8"	
	3-1-0103	1/2"	
	3-1-0105	3/4"	
	3-1-0106	1"	
	3-1-0107	1 1/4"	
	3-1-0108	1 1/2"	
	3-1-0109	2"	

	3-1-200A	1/8"	ΑΡΣΕΝΙΚΟ ΙΝΤΣΑΣ ΓΩΝΙΑ 45*
	3-1-200	1/4"	
	3-1-202	3/8"	
	3-1-203	1/2"	
	3-1-205	3/4"	
	3-1-206	1"	
	3-1-207	1 1/4"	
	3-1-208	1 1/2"	
	3-1-209	2"	

	3-1-210A	1/8"	ΑΡΣΕΝΙΚΟ-ΘΗΛΥΚΟ ΙΝΤΣΑΣ ΓΩΝΙΑ 45*
	3-1-210	1/4"	
	3-1-212	3/8"	
	3-1-213	1/2"	
	3-1-215	3/4"	
	3-1-216	1"	

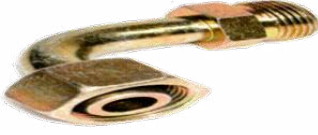
ΑΝΟΔΟΣ- ΔΗΜ Ι ΣΟΥΑΝΗΣ

3-ΝΙΠΕΛ ΣΠΕΙΡΩΜΑ ΙΝΤΣΑΣ

	ΚΩΔΙΚΟΣ	ΣΠΕΙΡΩΜΑ	
	3-1-300A	1/8"	ΑΡΣΕΝΙΚΟ ΙΝΤΣΑΣ ΓΩΝΙΑ 90*
	3-1-300	1/4"	
	3-1-302	3/8"	
	3-1-303	1/2"	
	3-1-305	3/4"	
	3-1-306	1"	
	3-1-307	1 1/4"	
	3-1-308	1 1/2"	
	3-1-309	2"	
	3-1-310A	1/8"	ΑΡΣΕΝΙΚΟ-ΘΗΛΥΚΟ ΙΝΤΣΑΣ ΓΩΝΙΑ 90*
	3-1-310	1/4"	
	3-1-312	3/8"	
	3-1-313	1/2"	
	3-1-315	3/4"	
	3-1-316	1"	
	3-1-317	1 1/4"	
	3-1-318	1 1/2"	
		3-1-400A	
3-1-400		1/4"	
3-1-402		3/8"	
3-1-403		1/2"	
3-1-405		3/4"	
3-1-406		1"	
3-1-407		1 1/4"	
3-1-408		1 1/2"	
		3-1-0400A	1/8"
	3-1-0400	1/4"	
	3-1-0402	3/8"	
	3-1-0403	1/2"	
	3-1-0405	3/4"	
	3-1-0406	1"	
	3-1-0410A	1/8"	ΙΝΤΣΑ ΘΗΛΥΚΟ-ΘΗΛΥΚΟ ΓΩΝΙΑ 90* ΣΤΑΘΕΡΟ
	3-1-0410	1/4"	
	3-1-0412	3/8"	
	3-1-0413	1/2"	
	3-1-0415	3/4"	
	3-1-0416	1"	
	3-1-103-15AN	1/2"-22X1,5 ΜΑΚΡΥ-ΚΟΝΤΡΑ	ΓΩΝΙΑ ΑΝΑΤΡΟΠΗΣ

ΑΝΟΔΟΣ- ΔΗΜ Ι ΣΟΥΑΝΗΣ

3-ΝΙΠΕΛ ΣΠΕΙΡΩΜΑ ΙΝΤΣΑΣ

	ΚΩΔΙΚΟΣ	ΣΠΕΙΡΩΜΑ	
	3-1-030	1/4"	ΑΡΣΕΝΙΚΟ ΙΝΤΣΑΣ ΤΑΦ
	3-1-032	3/8"	
	3-1-033	1/2"	
	3-1-035	3/4"	
	3-1-036	1"	
	3-1-037	1 1/4"	
	3-1-038	1 1/2"	
	3-1-039	2"	

	3-1-0300	1/4"	Α-Α-Θ ΙΝΤΣΑΣ ΤΑΦ ΤΡΕΛΛΟ
	3-1-0302	3/8"	
	3-1-0303	1/2"	
	3-1-0305	3/4"	
	3-1-0306	1"	

	3-1-03010	1/4"	Α-Θ-Α ΙΝΤΣΑΣ ΤΑΦ ΤΡΕΛΛΟ
	3-1-03012	3/8"	
	3-1-03013	1/2"	
	3-1-03015	3/4"	
	3-1-03016	1"	

	3-1-03020	1/4"	Α-Θ-Θ ΙΝΤΣΑΣ ΤΑΦ ΤΡΕΛΛΟ
	3-1-03022	3/8"	
	3-1-03023	1/2"	
	3-1-03025	3/4"	
	3-1-03026	1"	

	3-1-03030	1/4"	Θ-Α-Θ ΙΝΤΣΑΣ ΤΑΦ ΤΡΕΛΛΟ
	3-1-03032	3/8"	
	3-1-03033	1/2"	
	3-1-03035	3/4"	
	3-1-03036	1"	

	3-1-03040	1/4"	Θ-Θ-Θ ΙΝΤΣΑΣ ΤΑΦ ΤΡΕΛΛΟ
	3-1-03042	3/8"	
	3-1-03043	1/2"	
	3-1-03045	3/4"	
	3-1-03046	1"	

ΑΝΟΔΟΣ- ΔΗΜ Ι ΣΟΥΑΝΗΣ

3-ΝΙΠΕΛ ΣΠΕΙΡΩΜΑ ΙΝΤΣΑΣ

	ΚΩΔΙΚΟΣ	ΣΠΕΙΡΩΜΑ	
	3-1-04000A	1/8"	ΜΟΥΦΑ ΙΝΤΣΑΣ ΘΗΛΥΚΟ-ΘΗΛΥΚΟ ΣΤΑΘΕΡΟ
	3-1-04000	1/4"	
	3-1-04002	3/8"	
	3-1-04003	1/2"	
	3-1-04005	3/4"	
	3-1-04006	1"	

	3-1-03140	1/4"	Θ-Θ-Θ ΙΝΤΣΑΣ ΘΗΛΥΚΟ ΣΤΑΘΕΡΟ
	3-1-03142	3/8"	
	3-1-03143	1/2"	
	3-1-03145	3/4"	
	3-1-03146	1"	

		Α	Θ	
	3-1-0400A1	1/8"	1/4"	ΣΥΣΤΟΛΗ ΑΡΣΕΝΙΚΟ-ΘΗΛΥΚΟ ΣΤΑΘΕΡΟ
	3-1-0400A2	1/8"	3/8"	
	3-1-0400A3	1/4"	1/8"	
	3-1-04002A	1/4"	3/8"	
	3-1-04003A	1/4"	1/2"	
	3-1-04020	3/8"	1/4"	
	3-1-04023	3/8"	1/2"	
	3-1-04032	1/2"	3/8"	
	3-1-04035	1/2"	3/4"	
	3-1-04053	3/4"	1/2"	
	3-1-04056	3/4"	1"	
	3-1-04065	1"	3/4"	
	3-1-04067	1"	1 1/4"	
	3-1-04068	1"	1 1/2"	
	3-1-04076	1 1/4"	1"	
	3-1-04078	1 1/4"	1 1/2"	
3-1-04089	1 1/2"	2"		

	3-1-04120A	3/8"	1/8"	ΣΥΣΤΟΛΗ ΑΜΕΡΙΚΗΣ ΑΡΣΕΝΙΚΟ-ΘΗΛΥΚΟ ΣΤΑΘΕΡΟ
	3-1-04120	3/8"	1/4"	
	3-1-04130A	1/2"	1/8"	
	3-1-04130	1/2"	1/4"	
	3-1-04132	1/2"	3/8"	
	3-1-04152	3/4"	3/8"	
	3-1-04153	3/4"	1/2"	
	3-1-04163	1"	1/2"	

	3-1-04200A	1/8"	1/8"	ΠΡΟΕΚΤΑΣΗ ΑΡΣΕΝΙΚΟ-ΘΗΛΥΚΟ ΣΤΑΘΕΡΟ
	3-1-04200	1/4"	1/4"	
	3-1-04202	3/8"	3/8"	
	3-1-04203	1/2"	1/2"	
	3-1-04205	3/4"	3/4"	
	3-1-04206	1"	1"	

ΑΝΟΔΟΣ- ΔΗΜΙΣΟΥΑΝΗΣ

3-ΝΙΠΕΛ ΙΝΤΣΑΣ (ΙΝΤΣΑ ΒΑΣΕΩΣ-ΜΕΤΡΙΚΟ)

	ΚΩΔΙΚΟΣ	ΣΠΕΙΡ.ΒΑΣΗΣ	ΟΔΗΓΟΣ	
	3-1-100-4LL	1/8"	8X1,0-4LL	ΝΙΠΕΛ ΜΕΤΡΙΚΟ ΙΝΤΣΑ ΒΑΣΕΩΣ ΙΣΙΟ ΣΕΙΡΑ L
	3-1-100-6LL	1/8"	10X1,0-6LL	
	3-1-100A6	1/8"	12X1,5-6L	
	3-1-100A8	1/8"	14X1,5-8L	
	3-1-100-6	1/4"	12X1,5-6L	
	3-1-100-8	1/4"	14X1,5-8L	
	3-1-100-10	1/4"	16X1,5-10L	
	3-1-100-12	1/4"	18X1,5-12L	
	3-1-102-8	3/8"	14X1,5-8L	
	3-1-102-10	3/8"	16X1,5-10L	
	3-1-102-12	3/8"	18X1,5-12L	
	3-1-102-15	3/8"	22X1,5-15L	
	3-1-103-8	1/2"	14X1,5-8L	
	3-1-103-10	1/2"	16X1,5-10L	
	3-1-103-12	1/2"	18X1,5-12L	
	3-1-103-15	1/2"	22X1,5-15L	
	3-1-103-18	1/2"	26X1,5-18L	
	3-1-105-15	3/4"	22X1,5-15L	
	3-1-105-18	3/4"	26X1,5-18L	
	3-1-105-22	3/4"	30X2,0-22L	
	3-1-106-22	1"	30X2,0-22L	
	3-1-106-28	1"	36X2,0-28L	
	3-1-107-28	1 1/4"	36X2,0-28L	
	3-1-107-35	1 1/4"	45X2,0-35L	
	3-1-107-42	1 1/4"	52X2,0-42L	
	3-1-108-42	1 1/2"	52X2,0-42L	

	ΚΩΔΙΚΟΣ	ΣΠΕΙΡ.ΒΑΣΗΣ	ΟΔΗΓΟΣ	
	3-1-200-6	1/4"	14X1,5-6S	ΝΙΠΕΛ ΜΕΤΡΙΚΟ ΙΝΤΣΑ ΒΑΣΕΩΣ ΙΣΙΟ ΣΕΙΡΑ S
	3-1-200-8	1/4"	16X1,5-8S	
	3-1-200-10	1/4"	18X1,5-10S	
	3-1-202-8	3/8"	16X1,5-8S	
	3-1-202-10	3/8"	18X1,5-10S	
	3-1-202-12	3/8"	20X1,5-12S	
	3-1-202-14	3/8"	22X1,5-14S	
	3-1-203-10	1/2"	18X1,5-10S	
	3-1-203-12	1/2"	20X1,5-12S	
	3-1-203-14	1/2"	22X1,5-14S	
	3-1-203-16	1/2"	24X1,5-16S	
	3-1-205-16	3/4"	24X1,5-16S	
	3-1-205-20	3/4"	30X2,0-20S	
	3-1-206-20	1"	30X2,0-20S	
	3-1-206-25	1"	36X2,0-25S	
	3-1-206-30	1"	42X2,0-30S	
	3-1-207-30	1 1/4"	42X2,0-30S	
	3-1-207-38	1 1/4"	52X2,0-38S	
	3-1-208-38	1 1/2"	52X2,0-38S	

3-ΝΙΠΕΛ ΙΝΤΣΑΣ ΓΩΝΙΑ

ΑΝΟΔΟΣ- ΔΗΜ Ι ΣΟΥΑΝΗΣ

	ΚΩΔΙΚΟΣ	ΣΠΕΙΡ.ΒΑΣΗΣ	ΟΔΗΓΟΣ	
	3-1-110A4	1/8"	8X1,0-4LL	ΙΝΤΣΑ ΒΑΣΕΩΣ ΜΕΤΡΙΚΟ ΓΩΝΙΑ ΣΕΙΡΑ L
	3-1-110AA6	1/8"	10X1,0-6LL	
	3-1-110A6	1/8"	12X1,5-6L	
	3-1-110A8	1/8"	14X1,5-8L	
	3-1-110-6	1/4"	12X1,5-6L	
	3-1-110-8	1/4"	14X1,5-8L	
	3-1-110-10	1/4"	16X1,5-10L	
	3-1-110-12	1/4"	18X1,5-12L	
	3-1-112-8	3/8"	14X1,5-8L	
	3-1-112-10	3/8"	16X1,5-10L	
	3-1-112-12	3/8"	18X1,5-12L	
	3-1-112-15	3/8"	22X1,5-15L	
	3-1-113-10	1/2"	16X1,5-10L	
	3-1-113-12	1/2"	18X1,5-12L	
	3-1-113-15	1/2"	22X1,5-15L	
	3-1-113-18	1/2"	26X1,5-18L	
	3-1-115-18	3/4"	26X1,5-18L	
	3-1-115-22	3/4"	30X2,0-22L	
	3-1-116-28	1"	36X2,0-28L	

	3-1-210-6	1/4"	14X1,5-6S	ΙΝΤΣΑ ΒΑΣΕΩΣ ΜΕΤΡΙΚΟ ΓΩΝΙΑ ΣΕΙΡΑ S
	3-1-210-8	1/4"	16X1,5-8S	
	3-1-212-8	3/8"	16X1,5-8S	
	3-1-212-10	3/8"	18X1,5-10S	
	3-1-212-12	3/8"	20X1,5-12S	
	3-1-213-10	1/2"	18X1,5-10S	
	3-1-213-12	1/2"	20X1,5-12S	
	3-1-213-14	1/2"	22X1,5-14S	
	3-1-213-16	1/2"	24X1,5-16S	
	3-1-215-20	3/4"	30X2,0-20S	
	3-1-215-25	3/4"	36X2,0-25S	
	3-1-216-25	1"	36X2,0-25S	
	3-1-216-30	1"	42X2,0-30S	

ΑΝΟΔΟΣ- ΔΗΜ Ι ΣΟΥΑΝΗΣ

3-ΝΙΠΕΛ ΜΕΤΡΙΚΟ ΣΠΕΙΡΩΜΑ

	ΚΩΔΙΚΟΣ	ΣΠΕΙΡΩΜΑ	ΟΔΗΓΟΣ	
	3-2-100A4	8X1,0	4LL	ΝΙΠΕΛ ΜΕΤΡΙΚΟ ΙΣΙΟ ΣΕΙΡΑ L
	3-2-100A5	10X1,0	5LL	
	3-2-100A6	10X1,0	6LL	
	3-2-100A8	12X1,0	8LL	
	3-2-100-6	12X1,5	6L	
	3-2-100-8	14X1,5	8L	
	3-2-100-10	16X1,5	10L	
	3-2-100-12	18X1,5	12L	
	3-2-100-15	22X1,5	15L	
	3-2-100-18	26X1,5	18L	
	3-2-100-22	30X2,0	22L	
	3-2-100-28	36X2,0	28L	
	3-2-100-35	45X2,0	35L	
	3-2-100-42	52X2,0	42L	

	3-2-200-6	14X1,5	6S	ΝΙΠΕΛ ΜΕΤΡΙΚΟ ΙΣΙΟ ΣΕΙΡΑ S
	3-2-200-8	16X1,5	8S	
	3-2-200-10	18X1,5	10S	
	3-2-200-12	20X1,5	12S	
	3-2-200-14	22X1,5	14S	
	3-2-200-16	24X1,5	16S	
	3-2-200-20	30X2,0	20S	
	3-2-200-25	36X2,0	25S	
	3-2-200-30	42X2,0	30S	
	3-2-200-38	52X2,0	38S	

	3-2-101-6	12X1,5	6L	ΝΙΠΕΛ ΜΕΤΡΙΚΟ ΙΣΙΟ ΜΑΚΡΥ ΣΕΙΡΑ L
	3-2-101-8	14X1,5	8L	
	3-2-101-10	16X1,5	10L	
	3-2-101-12	18X1,5	12L	
	3-2-101-15	22X1,5	15L	
	3-2-101-18	26X1,5	18L	
	3-2-101-22	30X2,0	22L	
	3-2-101-28	36X2,0	28L	

	3-2-102-6	12X1,5	6L	ΝΙΠΕΛ ΜΕΤΡΙΚΟ ΓΩΝΙΑ ΜΑΚΡΥ ΣΕΙΡΑ L
	3-2-102-8	14X1,5	8L	
	3-2-102-10	16X1,5	10L	
	3-2-102-12	18X1,5	12L	
	3-2-102-15	22X1,5	15L	
	3-2-102-18	26X1,5	18L	
	3-2-102-22	30X2,0	22L	
	3-2-102-28	36X2,0	28L	

ΑΝΟΔΟΣ- ΔΗΜ Ι ΣΟΥΑΝΗΣ

3-ΝΙΠΕΛ ΜΕΤΡΙΚΟ ΣΠΕΙΡΩΜΑ

	ΚΩΔΙΚΟΣ	ΟΔΗΓΟΣ	
	3-2-201-6	14X1,5	6S
	3-2-201-8	16X1,5	8S
	3-2-201-10	18X1,5	10S
	3-2-201-12	20X1,5	12S
	3-2-201-14	22X1,5	14S
	3-2-201-16	24X1,5	16S
	3-2-201-20	30X2,0	20S
	3-2-201-25	36X2,0	25S
	3-2-201-30	42X2,0	30S
	3-2-201-38	52X2,0	38S

**ΝΙΠΕΛ
ΜΕΤΡΙΚΟ ΙΣΙΟ
ΜΑΚΡΥ
ΣΕΙΡΑ S**

	3-2-202-6	14X1,5	6S
	3-2-202-8	16X1,5	8S
	3-2-202-10	18X1,5	10S
	3-2-202-12	20X1,5	12S
	3-2-202-14	22X1,5	14S
	3-2-202-16	24X1,5	16S
	3-2-202-20	30X2,0	20S
	3-2-202-25	36X2,0	25S
	3-2-202-30	42X2,0	30S
	3-2-202-38	52X2,0	38S

**ΝΙΠΕΛ
ΜΕΤΡΙΚΟ ΓΩΝΙΑ
ΜΑΚΡΥ
ΣΕΙΡΑ S**

	3-2-10-61	6L-8L	
	3-2-10-62	6L-10L	
	3-2-10-63	6L-12L	
	3-2-10-81	8L-10L	
	3-2-10-82	8L-12L	
	3-2-10-83	8L-15L	
	3-2-10-101	10L-12L	
	3-2-10-102	10L-15L	
	3-2-10-121	12L-15L	
	3-2-10-122	12L-18L	
	3-2-10-151	15L-18L	
	3-2-10-152	15L-22L	
	3-2-10-221	22L-28L	





**ΝΙΠΕΛ
ΜΕΤΡΙΚΟ
ΣΥΣΤΟΛΙΚΟ
ΣΕΙΡΑ L**

	3-2-20-61	6S-8S	
	3-2-20-62	6S-10S	
	3-2-20-63	6S-12S	
	3-2-20-81	8S-10S	
	3-2-20-82	8S-12S	
	3-2-20-101	10S-12S	
	3-2-20-102	10S-14S	
	3-2-20-121	12S-14S	
	3-2-20-122	12S-16S	
	3-2-20-141	14S-16S	
	3-2-20-201	20S-25S	
	3-2-20-251	25S-30S	

**ΝΙΠΕΛ
ΜΕΤΡΙΚΟ
ΣΥΣΤΟΛΙΚΟ
ΣΕΙΡΑ S**

ΑΝΟΔΟΣ- ΔΗΜ Ι ΣΟΥΑΝΗΣ

3-ΝΙΠΕΛ ΜΕΤΡΙΚΟ ΣΠΕΙΡΩΜΑ ΓΩΝΙΑ

	ΚΩΔΙΚΟΣ	ΣΠΕΙΡΩΜΑ	ΟΔΗΓΟΣ			
	3-2-110A4	8X1,0	4LL-4LL	ΜΕΤΡΙΚΟ ΑΡΣΕΝΙΚΟ-ΑΡΣΕΝΙΚΟ ΓΩΝΙΑ ΣΕΙΡΑ L		
	3-2-110A5	10X1,0	5LL-5LL			
	3-2-110A6	10X1,0	6LL-6LL			
	3-2-110A8	12X1,0	8LL-8LL			
	3-2-110-6	12X1,5	6L-6L			
	3-2-110-8	14X1,5	8L-8L			
	3-2-110-10	16X1,5	10L-10L			
	3-2-110-12	18X1,5	12L-12L			
	3-2-110-15	22X1,5	15L-15L			
	3-2-110-18	26X1,5	18L-18L			
	3-2-110-22	30X2,0	22L-22L			
	3-2-110-28	36X2,0	28L-28L			
	3-2-110-35	45X2,0	35L-35L			
3-2-110-42	52X2,0	42L-42L				
	3-2-210-6	14X1,5	6S-6S	ΜΕΤΡΙΚΟ ΑΡΣΕΝΙΚΟ-ΑΡΣΕΝΙΚΟ ΓΩΝΙΑ ΣΕΙΡΑ S		
	3-2-210-8	16X1,5	8S-8S			
	3-2-210-10	18X1,5	10S-10S			
	3-2-210-12	20X1,5	12S-12S			
	3-2-210-14	22X1,5	14S-14S			
	3-2-210-16	24X1,5	16S-16S			
	3-2-210-20	30X2,0	20S-20S			
	3-2-210-25	36X2,0	25S-25S			
	3-2-210-30	42X2,0	30S-30S			
	3-2-210-38	52X2,0	38S-38S			
		3-2-111A4	8X1,0		4LL-4LL	ΜΕΤΡΙΚΟ ΑΡΣΕΝΙΚΟ-ΘΗΛΥΚΟ ΓΩΝΙΑ ΣΕΙΡΑ L
		3-2-111A5	10X1,0		5LL-5LL	
		3-2-111A6	10X1,0		6LL-6LL	
3-2-111A8		12X1,0	8LL-8LL			
3-2-111-6		12X1,5	6L-6L			
3-2-111-8		14X1,5	8L-8L			
3-2-111-10		16X1,5	10L-10L			
3-2-111-12		18X1,5	12L-12L			
3-2-111-15		22X1,5	15L-15L			
3-2-111-18		26X1,5	18L-18L			
3-2-111-22		30X2,0	22L-22L			
3-2-111-28		36X2,0	28L-28L			
3-2-111-35		45X2,0	35L-35L			
3-2-111-42	52X2,0	42L-42L				
	3-2-211-6	14X1,5	6S-6S	ΜΕΤΡΙΚΟ ΑΡΣΕΝΙΚΟ-ΘΗΛΥΚΟ ΓΩΝΙΑ ΣΕΙΡΑ S		
	3-2-211-8	16X1,5	8S-8S			
	3-2-211-10	18X1,5	10S-10S			
	3-2-211-12	20X1,5	12S-12S			
	3-2-211-14	22X1,5	14S-14S			
	3-2-211-16	24X1,5	16S-16S			
	3-2-211-20	30X2,0	20S-20S			
	3-2-211-25	36X2,0	25S-25S			
	3-2-211-30	42X2,0	30S-30S			
	3-2-211-38	52X2,0	38S-38S			

ΑΝΟΔΟΣ- ΔΗΜ Ι ΣΟΥΑΝΗΣ

3-ΝΙΠΕΛ ΜΕΤΡΙΚΟ ΣΠΕΙΡΩΜΑ ΤΑΦ

	ΚΩΔΙΚΟΣ	ΣΠΕΙΡΩΜΑ	ΟΔΗΓΟΣ	
	3-2-120A4	8X1,0	4LL	ΜΕΤΡΙΚΟ ΑΡΣ.-ΑΡΣ.-ΑΡΣ. ΤΑΦ ΣΕΙΡΑ L
	3-2-120A5	8X1,0	5LL	
	3-2-120A6	10X1,0	6LL	
	3-2-120A8	12X1,0	8LL	
	3-2-120-6	12X1,5	6L	
	3-2-120-8	14X1,5	8L	
	3-2-120-10	16X1,5	10L	
	3-2-120-12	18X1,5	12L	
	3-2-120-15	22X1,5	15L	
	3-2-120-18	26X1,5	18L	
	3-2-120-22	30X2,0	22L	
	3-2-120-28	36X2,0	28L	
	3-2-120-35	45X2,0	35L	
	3-2-120-42	52X2,0	42L	

	3-2-220-6	14X1,5	6S	ΜΕΤΡΙΚΟ ΑΡΣ.-ΑΡΣ.-ΑΡΣ. ΤΑΦ ΣΕΙΡΑ S
	3-2-220-8	16X1,5	8S	
	3-2-220-10	18X1,5	10S	
	3-2-220-12	20X1,5	12S	
	3-2-220-14	22X1,5	14S	
	3-2-220-16	24X1,5	16S	
	3-2-220-20	30X2,0	20S	
	3-2-220-25	36X2,0	25S	
	3-2-220-30	42X2,0	30S	
	3-2-220-38	52X2,0	38S	

	3-2-1200-6	12X1,5	6L	ΜΕΤΡΙΚΟ ΑΡΣ.-ΑΡΣ.-ΑΡΣ. ΣΤΑΥΡΟΣ
	3-2-1200-8	14X1,5	8L	
	3-2-1200-10	16X1,5	10L	
	3-2-1200-12	18X1,5	12L	
	3-2-1200-12S	20X1,5	12S	
	3-2-1200-14	22X1,5	14S	
	3-2-1200-15	22X1,5	15L	
	3-2-1200-16	24X1,5	16S	
	3-2-1200-18	26X1,5	18L	

ΑΝΟΔΟΣ- ΔΗΜ Ι ΣΟΥΑΝΗΣ

3-ΝΙΠΕΛ ΜΕΤΡΙΚΟ ΣΠΕΙΡΩΜΑ ΤΑΦ

	ΚΩΔΙΚΟΣ	ΣΠΕΙΡΩΜΑ	ΟΔΗΓΟΣ	ΜΕΤΡΙΚΟ
	3-2-121A4	8X1,0	4LL	ΑΡΣ.-ΑΡΣ.-ΘΗΛ. ΤΑΦ ΣΕΙΡΑ L
	3-2-121-6	12X1,5	6L	
	3-2-121-8	14X1,5	8L	
	3-2-121-10	16X1,5	10L	
	3-2-121-12	18X1,5	12L	
	3-2-121-15	22X1,5	15L	
	3-2-121-18	26X1,5	18L	
	3-2-121-22	30X2,0	22L	
	3-2-121-28	36X2,0	28L	
	3-2-121-35	45X2,0	35L	
	3-2-121-42	52X2,0	42L	

	3-2-221-6	14X1,5	6S	ΜΕΤΡΙΚΟ ΑΡΣ.-ΑΡΣ.-ΘΗΛ. ΤΑΦ ΣΕΙΡΑ S
	3-2-221-8	16X1,5	8S	
	3-2-221-10	18X1,5	10S	
	3-2-221-12	20X1,5	12S	
	3-2-221-14	22X1,5	14S	
	3-2-221-16	24X1,5	16S	
	3-2-221-20	30X2,0	20S	
	3-2-221-25	36X2,0	25S	
	3-2-221-30	42X2,0	30S	
	3-2-221-38	52X2,0	38S	

	3-2-122A4	8X1,0	4LL	ΜΕΤΡΙΚΟ ΑΡΣ.-ΘΗΛ.-ΑΡΣ. ΤΑΦ ΣΕΙΡΑ L
	3-2-122-6	12X1,5	6L	
	3-2-122-8	14X1,5	8L	
	3-2-122-10	16X1,5	10L	
	3-2-122-12	18X1,5	12L	
	3-2-122-15	22X1,5	15L	
	3-2-122-18	26X1,5	18L	
	3-2-122-22	30X2,0	22L	
	3-2-122-28	36X2,0	28L	
	3-2-122-35	45X2,0	35L	
	3-2-122-42	52X2,0	42L	

	3-2-222-6	14X1,5	6S	ΜΕΤΡΙΚΟ ΑΡΣ.-ΘΗΛ.-ΑΡΣ. ΤΑΦ ΣΕΙΡΑ S
	3-2-222-8	16X1,5	8S	
	3-2-222-10	18X1,5	10S	
	3-2-222-12	20X1,5	12S	
	3-2-222-14	22X1,5	14S	
	3-2-222-16	24X1,5	16S	
	3-2-222-20	30X2,0	20S	
	3-2-222-25	36X2,0	25S	
	3-2-222-30	42X2,0	30S	
	3-2-222-38	52X2,0	38S	

ΑΝΟΔΟΣ- ΔΗΜ Ι ΣΟΥΑΝΗΣ

3-ΝΙΠΕΛ ΜΕΤΡΙΚΟ ΣΠΕΙΡΩΜΑ ΒΑΣΕΩΣ

	ΚΩΔΙΚΟΣ	ΣΠΕΙΡ.ΒΑΣΗΣ	ΟΔΗΓΟΣ	
	3-2-130-6A	8X1,0	10X1,0-6LL	ΝΙΠΕΛ ΜΕΤΡΙΚΟ ΒΑΣΕΩΣ ΣΕΙΡΑ L
	3-2-130-6	10X1	12X1,5-6L	
	3-2-131-6	12X1,5	12X1,5-6L	
	3-2-131-8	12X1,5	14X1,5-8L	
	3-2-132-8	14X1,5	14X1,5-8L	
	3-2-132-10	14X1,5	16X1,5-10L	
	3-2-133-10	16X1,5	16X1,5-10L	
	3-2-133-12	16X1,5	18X1,5-12L	
	3-2-134-12	18X1,5	18X1,5-12L	
	3-2-134-15	18X1,5	22X1,5-15L	
	3-2-134-18	18X1,5	26X1,5-18L	
	3-2-135-6	22X1,5	12X1,5-6L	
	3-2-135-8	22X1,5	14X1,5-8L	
	3-2-135-10	22X1,5	16X1,5-10L	
	3-2-135-12	22X1,5	18X1,5-12L	
	3-2-135-15	22X1,5	22X1,5-15L	
	3-2-135-18	22X1,5	26X1,5-18L	
	3-2-135-22	22X1,5	30X2,0-22L	
	3-2-136-18	26X1,5	26X1,5-18L	
	3-2-136-22	26X1,5	30X2,0-22L	
3-2-137-22	33X2,0	30X2,0-22L		
3-2-137-28	33X2,0	36X2,0-28L		
3-2-138-35	42X2,0	45X2,0-35L		

	3-2-231-6	12X1,5	14X1,5-6S	ΝΙΠΕΛ ΜΕΤΡΙΚΟ ΒΑΣΕΩΣ ΣΕΙΡΑ S
	3-2-232-8	14X1,5	16X1,5-8S	
	3-2-233-10	16X1,5	18X1,5-10S	
	3-2-234-12	18X1,5	20X1,5-12S	
	3-2-234-14	18X1,5	22X1,5-14S	
	3-2-234-16	18X1,5	24X1,5-16S	
	3-2-235-14	20X1,5	22X1,5-14S	
	3-2-236-12	22X1,5	20X1,5-12S	
	3-2-236-14	22X1,5	22X1,5-14S	
	3-2-236-16	22X1,5	24X1,5-16S	
	3-2-237-20	27X2,0	30X2,0-20S	
	3-2-237-25	27X2,0	36X2,0-25S	
	3-2-238-25	33X2,0	36X2,0-25S	
	3-2-238-30	33X2,0	42X2,0-30S	
	3-2-239-30	42X2,0	42X2,0-30S	
	3-2-239-38	42X2,0	52X2,0-38S	

ΑΝΟΔΟΣ- ΔΗΜ Ι ΣΟΥΑΝΗΣ

3-ΝΙΠΕΛ ΜΕΤΡΙΚΟ ΣΠΕΙΡΩΜΑ ΒΑΣΕΩΣ



ΚΩΔΙΚΟΣ	ΣΠΕΙΡ.ΒΑΣΗΣ	ΟΔΗΓΟΣ	ΡΑΚΟΡ ORIENTAL ΚΑΡΦΙ-ΘΗΛΕΙΑ
3-1-130-4LL	1/8"	8X1,0-4LL	
3-1-130-6LL	1/8"	10X1,0-6LL	
3-1-130-8LL	1/8"	12X1,0-8LL	
3-1-130-A6	1/8"	12X1,5-6L	
3-1-130-6	1/4"	12X1,5-6L	
3-1-130-8	1/4"	14X1,5-8L	
3-1-130-10	1/4"	16X1,5-10L	
3-1-132-12	3/8"	18X1,5-12L	
3-1-133-15	1/2"	22X1,5-15L	
3-1-133-18	1/2"	26X1,5-18L	
3-1-135-22	3/4"	30X2,0-22L	
3-1-136-28	1"	36X2,0-28L	
3-1-137-35	1 1/4"	45X2,0-35L	
3-1-230-6	1/4"	14X1,5-6S	
3-1-230-8	1/4"	16X1,5-8S	
3-1-232-10	3/8"	18X1,5-10S	
3-1-232-12	3/8"	20X1,5-12S	
3-1-233-14	1/2"	22X1,5-14S	
3-1-233-16	1/2"	24X1,5-16S	
3-1-235-20	3/4"	30X2,0-20S	
3-1-236-25	1"	36X2,0-25S	
3-2-330-6	10X1	12X1,5-6L	
3-2-331-8	12X1,5	14X1,5-8L	
3-2-332-10	14X1,5	16X1,5-10L	
3-2-333-12	16X1,5	18X1,5-12L	
3-2-334-15	18X1,5	22X1,5-15L	
3-2-335-18	22X1,5	26X1,5-18L	
3-2-336-22	26X1,5	30X2,0-22L	
3-2-337-28	33X2,0	36X2,0-28L	
3-2-338-35	42X2,0	45X2,0-35L	
3-2-431-6	12X1,5	14X1,5-6S	
3-2-432-8	14X1,5	16X1,5-8S	
3-2-433-10	16X1,5	18X1,5-10S	
3-2-434-12	18X1,5	20X1,5-12S	
3-2-435-14	20X1,5	22X1,5-14S	
3-2-436-16	22X1,5	24X1,5-16S	
3-2-437-20	27X2,0	30X2,0-20S	
3-2-438-25	33X2,0	36X2,0-25S	
3-2-439-30	42X2,0	42X2,0-30S	

ΑΝΟΔΟΣ- ΔΗΜ Ι ΣΟΥΑΝΗΣ

4-ΣΩΛΗΝΩΤΑ ΡΑΚΟΡ (ΙΝΤΣΑ-ΜΕΤΡΙΚΟ)

	ΚΩΔΙΚΟΣ	KOR	ΣΠΕΙΡΩΜΑ	
	4-1-200A6	6MM	1/8"	ΣΩΛΗΝΩΤΑ ΡΑΚΟΡ ΙΝΤΣΑΣ KOR
	4-1-200-6	6MM	1/4"	
	4-1-200-8	8MM	1/4"	
	4-1-200-10	10MM	1/4"	
	4-1-202-10	10MM	3/8"	
	4-1-202-12	12MM	3/8"	
	4-1-202-15	15MM	3/8"	
	4-1-203-10	10MM	1/2"	
	4-1-203-12	12MM	1/2"	
	4-1-203-14	14MM	1/2"	
	4-1-203-15	15MM	1/2"	
	4-1-203-16	16MM	1/2"	
	4-1-205-18	18MM	3/4"	
	4-1-205-20	20MM	3/4"	
	4-1-205-25	25MM	3/4"	
	4-1-206-25	25MM	1"	

	ΚΩΔΙΚΟΣ	KOR	ΣΠΕΙΡΩΜΑ	
	4-2-2600	6MM	10X1	ΣΩΛΗΝΩΤΑ ΡΑΚΟΡ ΜΕΤΡΙΚΟ KOR
	4-2-2660	6MM	12X1,5	
	4-2-2860	8MM	12X1,5	
	4-2-21060	10MM	12X1,5	
	4-2-21080	10MM	14X1,5	
	4-2-21010	10MM	16X1,5	
	4-2-21212	12MM	18X1,5	
	4-2-21215	12MM	22X1,5	
	4-2-21218	12MM	26X1,5	
	4-2-21410	14MM	16X1,5	
	4-2-21412	14MM	18X1,5	
	4-2-21512	15MM	18X1,5	
	4-2-21515	15MM	22X1,5	
	4-2-21615	16MM	22X1,5	

ΑΝΟΔΟΣ- ΔΗΜ Ι ΣΟΥΑΝΗΣ



Π-ΠΑΞΙΜΑΔΙΑ

	ΚΩΔΙΚΟΣ	ΣΠΕΙΡΩΜΑ	ΟΔΗΓΟΣ	
	Π-2-10Α4	8X1,0	4LL	ΠΑΞΙΜΑΔΙΑ ΣΕΙΡΑ L
	Π-2-10Α6	10X1,0	6LL	
	Π-2-10-6	12X1,5	6L	
	Π-2-10-8	14X1,5	8L	
	Π-2-10-10	16X1,5	10L	
	Π-2-10-12	18X1,5	12L	
	Π-2-10-15	22X1,5	15L	
	Π-2-10-18	26X1,5	18L	
	Π-2-10-22	30X2,0	22L	
	Π-2-10-28	36X2,0	28L	
	Π-2-10-35	45X2,0	35L	
	Π-2-10-42	52X2,0	42L	

	Π-2-20-6	14X1,5	6S	ΠΑΞΙΜΑΔΙΑ ΣΕΙΡΑ S
	Π-2-20-8	16X1,5	8S	
	Π-2-20-10	18X1,5	10S	
	Π-2-20-12	20X1,5	12S	
	Π-2-20-14	22X1,5	14S	
	Π-2-20-16	24X1,5	16S	
	Π-2-20-20	30X2,0	20S	
	Π-2-20-25	36X2,0	25S	
	Π-2-20-30	42X2,0	30S	
	Π-2-20-38	52X2,0	38S	

ΑΝΟΔΟΣ- ΔΗΜ Ι ΣΟΥΑΝΗΣ

B-BΥΖΟΥΛΑ ΕΣΩΤΕΡΙΚΑ-ΕΞΩΤΕΡΙΚΑ (ΜΕΤΡΙΚΑ-ΙΝΤΣΑ)

	ΚΩΔΙΚΟΣ	ΟΔΗΓΟΣ		
	B-2-10A4	4LL	ΜΕΤΡΙΚΑ ΕΞΩΤΕΡΙΚΑ ΒΥΖΟΥΛΑ ΣΕΙΡΑ L	
	B-2-10A6	6LL		
	B-2-10-6	6L		
	B-2-10-8	8L		
	B-2-10-10	10L		
	B-2-10-12	12L		
	B-2-10-15	15L		
	B-2-10-18	18L		
	B-2-10-22	22L		
	B-2-10-28	28L		
	B-2-10-35	35L		
	B-2-10-42	42L		
	B-2-20-6	6S		ΜΕΤΡΙΚΑ ΕΞΩΤΕΡΙΚΑ ΒΥΖΟΥΛΑ ΣΕΙΡΑ S
	B-2-20-8	8S		
	B-2-20-10	10S		
	B-2-20-12	12S		
B-2-20-14	14S			
B-2-20-16	16S			
B-2-20-20	20S			
B-2-20-25	25S			
B-2-20-30	30S			
B-2-20-38	38S			
	B-2-11A	4X1	ΜΕΤΡΙΚΑ ΕΣΩΤΕΡΙΚΑ ΒΥΖΟΥΛΑ	
	B-2-11-6	6X1		
	B-2-11-8	8X1		
	B-2-11-10	10X1		
	B-2-11-10,5	10X1,5		
	B-2-11-12	12X1,5		
	B-2-11-15	15X1,5		
	B-2-11-16	16X2		
	B-2-11-18	18X2		
	B-1-10A	1/8"	ΕΞΩΤΕΡΙΚΑ ΒΥΖΟΥΛΑ ΙΝΤΣΑΣ	
	B-1-10AA	3/16"		
	B-1-10	1/4"		
	B-1-11	5/16"		
	B-1-12	3/8"		
	B-1-13	1/2"		
	B-1-14	5/8"		
	B-1-20A	1/8"		ΕΣΩΤΕΡΙΚΑ ΒΥΖΟΥΛΑ ΙΝΤΣΑΣ
B-1-20AA	3/16"			
B-1-20	1/4"			
B-1-21	5/16"			
B-1-22	3/8"			
B-1-23	1/2"			
B-1-24	5/8"			

ΑΝΟΔΟΣ- ΔΗΜ Ι ΣΟΥΑΝΗΣ

1-ΣΙΔΗΡΟΣΩΛΗΝΕΣ-ΧΑΛΚΟΣΩΛΗΝΕΣ

ΚΩΔΙΚΟΣ	ΔΙΑΣΤΑΣΗ	ΠΙΕΣΗ(ΑΤΜ.)	
1-1-0500A	5X1,0	380	ΣΙΔΗΡΟΣΩΛΗΝΕΣ ΠΙΕΣΕΩΣ ΕΛΑΙΟΥ
1-1-0500	6X1,0	340	
1-1-0501	8X1,0	260	
1-1-0501A	8X1,5		
1-1-0502A-M-M	10X1,0	210	
1-1-0502	10X1,5	330	
1-1-0503A	12X1,5	260	
1-1-0503	12X2,0	350	
1-1-0504	14X2,0	300	
1-1-0505A	15X2,0	280	
1-1-0505	15X1,5	200	
1-1-0506	16X2,0	260	
1-1-0507	18X1,5	200	
1-1-0508	20X2,5	250	
1-1-0508A	20X3,0	320	
1-1-0509	22X2,0	170	
1-1-0510	25X2,0	130	
1-1-0510A	25X2,5	190	
1-1-0510B	25X3,0	250	
1-1-0511	28X2,0	130	
1-1-0511A	28X2,5	130	
1-1-0512	30X2,5	150	
1-1-0512A-M-M	30X3,0	190	
1-1-0513	35X3,0	150	
1-1-0514	38X4,0	220	
1-1-0515	42X3,0	120	
1-1-0500-M	6X2 ΜΠΕΚ	1200	ΣΙΔΗΡΟΣΩΛΗΝΕΣ ΜΠΕΚ
1-1-0501M	8X2 ΜΠΕΚ	950	
1-1-0502M	8X2,5 ΜΠΕΚ	800	

1-2-0520	3/16"	0,165 KGR/M
1-2-0521	1/4"	0,170 KGR/M
1-2-0522	5/16"	0,210 KGR/M
1-2-0523	3/8"	0,260 KGR/M
1-2-0524	½"	0,300 KGR/M
1-2-0525	5/8"	0,450 KGR/M

ΝΙΠΕΛ ΣΟΥΗΔΙΚΟ ΣΠΕΙΡΩΜΑ

	3-4-100A	1/8"	ΝΙΠΕΛ ΣΟΥΗΔΙΚΟ ΣΠΕΙΡΩΜΑ
	3-4-100AA	3/16"	
	3-4-100	1/4"	
	3-4-102	3/8"	
	3-4-103	1/2"	
	3-4-104	5/8"	

ΑΝΟΔΟΣ- ΔΗΜ Ι ΣΟΥΑΝΗΣ

ΣΤ-ΣΤΗΡΙΓΜΑΤΑ ΣΩΛΗΝΩΝ ΜΟΝΑ-ΔΙΠΛΑ

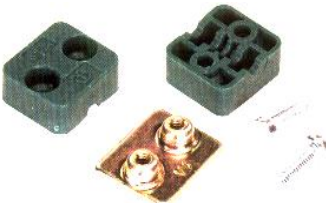
	ΚΩΔΙΚΟΣ	ΔΙΑΣΤΑΣΗ	
	ΣΤ-0006	6MM	ΣΤΗΡΙΓΜΑΤΑ ΜΟΝΑ
	ΣΤ-0008	8MM	
	ΣΤ-0010	10MM	
	ΣΤ-0012	12MM	
	ΣΤ-0014	14MM	
	ΣΤ-0015	15MM	
	ΣΤ-0016	16MM	
	ΣΤ-0018	18MM	
	ΣΤ-0020	20MM	
	ΣΤ-0022	22MM	
	ΣΤ-0025	25MM	
	ΣΤ-0028	28MM	
	ΣΤ-0030	30MM	
	ΣΤ-0035	35MM	
	ΣΤ-0038	38MM	
	ΣΤ-0040	40MM	
	ΣΤ-0042	42MM	
	ΣΤ-0045	45MM	
	ΣΤ-0048	48MM	
	ΣΤ-0116	16MM	ΣΤΗΡΙΓΜΑΤΑ ΜΟΝΑ ΒΑΡΕΩΣ ΤΥΠΟΥ
	ΣΤ-0120	20MM	
	ΣΤ-0125	25MM	
	ΣΤ-0130	30MM	
	ΣΤ-0138	38MM	
	ΣΤ-0142	42MM	
	ΣΤ-0150	50MM	
	ΣΤ-0160	60MM	

	ΣΤ-0206	6MM	ΣΤΗΡΙΓΜΑΤΑ ΔΙΠΛΑ
	ΣΤ-0208	8MM	
	ΣΤ-0210	10MM	
	ΣΤ-0212	12MM	
	ΣΤ-0214	14MM	
	ΣΤ-0215	15MM	
	ΣΤ-0216	16MM	
	ΣΤ-0218	18MM	
	ΣΤ-0220	20MM	
	ΣΤ-0222	22MM	
	ΣΤ-0225	25MM	
	ΣΤ-0228	28MM	
	ΣΤ-0230	30MM	
	ΣΤ-0235	35MM	
	ΣΤ-0238	38MM	
	ΣΤ-0240	40MM	
	ΣΤ-0242	42MM	

ΑΝΟΔΟΣ- ΔΗΜ Ι ΣΟΥΑΝΗΣ

3-ΝΙΠΕΛ ΣΠΕΙΡΩΜΑ ΙΝΤΣΑΣ UNF

	ΚΩΔΙΚΟΣ	ΣΠΕΙΡΩΜΑ	
	3-3-000	7/16"X20	ΝΙΠΕΛ ΙΣΙΟ UNF
	3-3-001	1/2"X20	
	3-3-002	9/16"X18	
	3-3-003	5/8"X18	
	3-3-004	3/4"X16	
	3-3-005	7/8"X14	
	3-3-006	1 1/16"X12	
	3-3-007	1 3/16"X12	
	3-3-008	1 5/16"X12	
	3-3-009	1 5/8"X12	
3-3-009A	1 7/8"X12		

	3-3-100	7/16"X20	ΝΙΠΕΛ ΠΙΝΑΚΟΣ ΙΝΤΣΑΣ ΙΣΙΟ UNF
	3-3-101	1/2"X20	
	3-3-102	9/16"X18	
	3-3-103	5/8"X18	
	3-3-104	3/4"X16	
	3-3-105	7/8"X14	
	3-3-106	1 1/16"X12	

	3-3-0001	7/16"-1/2"	ΝΙΠΕΛ ΙΝΤΣΑΣ ΣΥΣΤΟΛΙΚΟ UNF
	3-3-0002	7/16"-9/16"	
	3-3-0012	1/2"-9/16"	
	3-3-0014	1/2"-3/4"	
	3-3-0024	9/16"-3/4"	
	3-3-0025	9/16"-7/8"	
	3-3-0045	3/4"-7/8"	
	3-3-0046	3/4"-1 1/16"	
	3-3-0056	7/8"-1 1/16"	
	3-3-0067	1 1/16"-1 3/16"	
	3-3-0068	1 1/16"-1 5/16"	
	3-3-0078	1 3/16"-1 5/16"	
	3-3-0089	1 5/16"-1 5/8"	
	3-3-0089A	1 5/16"-1 7/8"	
	3-3-0089B	1 5/8"-1 7/8"	

ΑΝΟΔΟΣ- ΔΗΜ Ι ΣΟΥΑΝΗΣ

3-ΝΙΠΕΛ ΣΠΕΙΡΩΜΑ ΙΝΤΣΑΣ UNF

	ΚΩΔΙΚΟΣ	ΣΠΕΙΡΩΜΑ	
	3-3-200	7/16"X20	ΑΡΣΕΝΙΚΟ ΙΝΤΣΑΣ ΓΩΝΙΑ 45* UNF
	3-3-201	1/2"X20	
	3-3-202	9/16"X18	
	3-3-203	5/8"X18	
	3-3-204	3/4"X16	
	3-3-205	7/8"X14	
	3-3-206	1 1/16"X12	
	3-3-208	1 5/16"X12	

	3-3-210	7/16"X20	ΑΡΣΕΝΙΚΟ-ΘΗΛΥΚΟ ΙΝΤΣΑΣ ΓΩΝΙΑ 45* UNF
	3-3-211	1/2"X20	
	3-3-212	9/16"X18	
	3-3-213	5/8"X18	
	3-3-214	3/4"X16	
	3-3-215	7/8"X14	
	3-3-216	1 1/16"X12	
	3-3-218	1 5/16"X12	
	3-3-219	1 5/8"X12	
	3-3-219A	1 7/8"X12	

	3-3-300	7/16"X20	ΑΡΣΕΝΙΚΟ ΙΝΤΣΑΣ ΓΩΝΙΑ 90* UNF
	3-3-301	1/2"X20	
	3-3-302	9/16"X18	
	3-3-303	5/8"X18	
	3-3-304	3/4"X16	
	3-3-305	7/8"X14	
	3-3-306	1 1/16"X12	
	3-3-308	1 5/16"X12	
	3-3-309	1 5/8"X12	
	3-3-309A	1 7/8"X12	

	3-3-310	7/16"X20	ΑΡΣΕΝΙΚΟ-ΘΗΛΥΚΟ ΙΝΤΣΑΣ ΓΩΝΙΑ 90* UNF
	3-3-311	1/2"X20	
	3-3-312	9/16"X18	
	3-3-313	5/8"X18	
	3-3-314	3/4"X16	
	3-3-315	7/8"X14	
	3-3-316	1 1/16"X12	
	3-3-318	1 5/16"X12	
	3-3-319	1 5/8"X12	
	3-3-319A	1 7/8"X12	

ΑΝΟΔΟΣ- ΔΗΜ Ι ΣΟΥΑΝΗΣ

3-ΝΙΠΕΛ ΣΠΕΙΡΩΜΑ ΙΝΤΣΑΣ UNF

	ΚΩΔΙΚΟΣ	ΣΠΕΙΡΩΜΑ	
	3-3-030	7/16"X20	ΑΡΣΕΝΙΚΟ ΙΝΤΣΑΣ ΤΑΦ UNF
	3-3-031	1/2"X20	
	3-3-032	9/16"X18	
	3-3-033	5/8"X18	
	3-3-034	3/4"X16	
	3-3-035	7/8"X14	
	3-3-036	1 1/16"X12	
	3-3-038	1 5/16"X12	
	3-3-039	1 5/8"X12	
	3-3-039A	1 7/8"X12	

	ΚΩΔΙΚΟΣ	ΣΠΕΙΡΩΜΑ	
	3-3-0300	7/16"X20	Α-Α-Θ ΙΝΤΣΑΣ ΤΑΦ ΤΡΕΛΛΟ UNF
	3-3-0301	1/2"X20	
	3-3-0302	9/16"X18	
	3-3-0303	5/8"X18	
	3-3-0304	3/4"X16	
	3-3-0305	7/8"X14	
	3-3-0306	1 1/16"X12	
	3-3-0308	1 5/16"X12	
	3-3-0309	1 5/8"X12	
	3-3-0309A	1 7/8"X12	

	ΚΩΔΙΚΟΣ	ΣΠΕΙΡΩΜΑ	
	3-3-03010	7/16"X20	Α-Θ-Α ΙΝΤΣΑΣ ΤΑΦ ΤΡΕΛΛΟ UNF
	3-3-03011	1/2"X20	
	3-3-03012	9/16"X18	
	3-3-03013	5/8"X18	
	3-3-03014	3/4"X16	
	3-3-03015	7/8"X14	
	3-3-03016	1 1/16"X12	
	3-3-03018	1 5/16"X12	
	3-3-03019	1 5/8"X12	
	3-3-0-3019A	1 7/8"X12	

ΑΝΟΔΟΣ- ΔΗΜ Ι ΣΟΥΑΝΗΣ

3-ΝΙΠΕΛ ΣΠΕΙΡΩΜΑ ΙΝΤΣΑΣ UNF

	ΚΩΔΙΚΟΣ	ΣΠΕΙΡ.ΒΑΣΗΣ	ΣΠΕΙΡΩΜΑ	
		UNF	UNF	
	3-3-0000-00	7/16"	7/16"	ΝΙΠΕΛ ΒΑΣΕΩΣ ΙΝΤΣΑΣ ΑΡΣΕΝΙΚΟ-ΑΡΣΕΝΙΚΟ UNF-UNF
	3-3-0000-01	7/16"	1/2"	
	3-3-0000-02	7/16"	9/16"	
	3-3-0001-00	1/2"	7/16"	
	3-3-0001-01	1/2"	1/2"	
	3-3-0001-02	1/2"	9/16"	
	3-3-0002-00	9/16"	7/16"	
	3-3-0002-01	9/16"	1/2"	
	3-3-0002-02	9/16"	9/16"	
	3-3-0002-04	9/16"	3/4"	
	3-3-0004-02	3/4"	9/16"	
	3-3-0004-04	3/4"	3/4"	
	3-3-0004-05	3/4"	7/8"	
	3-3-0005-02	7/8"	9/16"	
	3-3-0005-04	7/8"	3/4"	
	3-3-0005-05	7/8"	7/8"	
	3-3-0005-06	7/8"	1 1/16"	
	3-3-0006-06	1 1/16"	1 1/16"	
	3-3-0006-07	1 1/16"	1 3/16"	
	3-3-0006-08	1 1/16"	1 5/16"	
3-3-0008-08	1 5/16"	1 5/16"		
3-3-0009-09	1 5/8"	1 5/8"		
3-3-0009-09A	1 7/8"	1 7/8"		

	ΚΩΔΙΚΟΣ	ΣΠΕΙΡ.ΒΑΣΗΣ	ΣΠΕΙΡΩΜΑ	
		UNF	UNF	
	3-3-0200-00	7/16"	7/16"	ΓΩΝΙΑ ΒΑΣΕΩΣ ΙΝΤΣΑΣ ΜΕ ΚΟΝΤΡΑ ΠΑΞΙΜΑΔΙ 45* UNF
	3-3-0201-00	1/2"	7/16"	
	3-3-0201-01	1/2"	1/2"	
	3-3-0201-02	1/2"	9/16"	
	3-3-0202-01	9/16"	1/2"	
	3-3-0202-02	9/16"	9/16"	
	3-3-0202-04	9/16"	3/4"	
	3-3-0204-02	3/4"	9/16"	
	3-3-0204-04	3/4"	3/4"	
	3-3-0204-05	3/4"	7/8"	
	3-3-0205-04	7/8"	3/4"	
	3-3-0205-05	7/8"	7/8"	
	3-3-0205-06	7/8"	1 1/16"	
	3-3-0206-06	1 1/16"	1 1/16"	
	3-3-0206-08	1 1/16"	1 5/16"	
	3-3-0208-08	1 5/16"	1 5/16"	
	3-3-0209-09	1 5/8"	1 5/8"	
	3-3-0209-09A	1 7/8"	1 7/8"	

ΑΝΟΔΟΣ- ΔΗΜ Ι ΣΟΥΑΝΗΣ

3-ΝΙΠΕΛ ΣΠΕΙΡΩΜΑ ΙΝΤΣΑΣ UNF

ΚΩΔΙΚΟΣ	ΣΠΕΙΡ.ΒΑΣΗΣ	ΣΠΕΙΡΩΜΑ	ΓΩΝΙΑ ΒΑΣΕΩΣ ΙΝΤΣΑΣ ΜΕ ΚΟΝΤΡΑ ΠΑΞΙΜΑΔΙ 90* UNF
	UNF	UNF	
	3-3-0300-00	7/16"	7/16"
	3-3-0300-01	7/16"	1/2"
	3-3-0301-00	1/2"	7/16"
	3-3-0301-01	1/2"	1/2"
	3-3-0301-02	1/2"	9/16"
	3-3-0302-00	9/16"	7/16"
	3-3-0302-01	9/16"	1/2"
	3-3-0302-02	9/16"	9/16"
	3-3-0302-04	9/16"	3/4"
	3-3-0304-02	3/4"	9/16"
	3-3-0304-04	3/4"	3/4"
	3-3-0304-05	3/4"	7/8"
	3-3-0305-04	7/8"	3/4"
	3-3-0305-05	7/8"	7/8"
	3-3-0305-06	7/8"	1 1/16"
	3-3-0306-06	1 1/16"	1 1/16"
	3-3-0306-07	1 1/16"	1 3/16"
	3-3-0306-08	1 1/16"	1 5/16"
	3-3-0308-08	1 5/16"	1 5/16"
	3-3-0309-09	1 5/8"	1 5/8"
3-3-0309-09A	1 7/8"	1 7/8"	

ΑΝΟΔΟΣ- ΔΗΜ Ι ΣΟΥΑΝΗΣ

3-ΝΙΠΕΛ ΣΠΕΙΡΩΜΑ ΙΝΤΣΑΣ UNF

	ΚΩΔΙΚΟΣ	ΣΠΕΙΡ.ΒΑΣΗΣ	ΣΠΕΙΡΩΜΑ	
		BSP	UNF	
	3-3-000A-00	1/8"	7/16"	ΝΙΠΕΛ ΒΑΣΕΩΣ ΙΝΤΣΑΣ ΑΡΣΕΝΙΚΟ-ΑΡΣΕΝΙΚΟ BSP-UNF
	3-3-000A-01	1/8"	1/2"	
	3-3-000A-02	1/8"	9/16"	
	3-3-000-00	1/4"	7/16"	
	3-3-000-01	1/4"	1/2"	
	3-3-000-02	1/4"	9/16"	
	3-3-000-03	1/4"	3/4"	
	3-3-002-00	3/8"	7/16"	
	3-3-002-01	3/8"	1/2"	
	3-3-002-02	3/8"	9/16"	
	3-3-002-03	3/8"	5/8"	
	3-3-002-04	3/8"	3/4"	
	3-3-002-05	3/8"	7/8"	
	3-3-003-02	1/2"	9/16"	
	3-3-003-03	1/2"	3/4"	
	3-3-003-05	1/2"	7/8"	
	3-3-003-06	1/2"	1 1/16"	
	3-3-004-05	5/8"	7/8"	
	3-3-005-04	3/4"	3/4"	
	3-3-005-05	3/4"	7/8"	
	3-3-005-06	3/4"	1 1/16"	
	3-3-005-07	3/4"	1 3/16"	
	3-3-005-08	3/4"	1 5/16"	
	3-3-006-06	1"	1 1/16"	
	3-3-006-07	1"	1 3/16"	
	3-3-006-08	1"	1 5/16"	
	3-3-007-07	1 1/4"	1 3/16"	
	3-3-007-08	1 1/4"	1 5/16"	
	3-3-007-09	1 1/4"	1 5/8"	
	3-3-007-09A	1 1/4"	1 7/8"	
	3-3-008-09	1 1/2"	1 5/8"	
	3-3-008-09A	1 1/2"	1 7/8"	

ΑΝΟΔΟΣ- ΔΗΜ Ι ΣΟΥΑΝΗΣ

3-ΝΙΠΕΛ ΣΠΕΙΡΩΜΑ ΙΝΤΣΑΣ UNF

	ΚΩΔΙΚΟΣ	ΣΠΕΙΡ.ΒΑΣΗΣ	ΣΠΕΙΡΩΜΑ	
		BSP	UNF	
	3-3-000A-000	1/8"	7/16"	ΝΙΠΕΛ ΒΑΣΕΩΣ ΙΝΤΣΑΣ ΑΡΣΕΝΙΚΟ-ΘΗΛΥΚΟ BSP-UNF
	3-3-000A-001	1/8"	1/2"	
	3-3-000-000	1/4"	7/16"	
	3-3-000-001	1/4"	1/2"	
	3-3-000-002	1/4"	9/16"	
	3-3-000-003	1/4"	3/4"	
	3-3-002-001	3/8"	1/2"	
	3-3-002-002	3/8"	9/16"	
	3-3-002-003	3/8"	5/8"	
	3-3-002-004	3/8"	3/4"	
	3-3-002-005	3/8"	7/8"	
	3-3-003-004	1/2"	3/4"	
	3-3-003-005	1/2"	7/8"	
	3-3-005-005	3/4"	7/8"	
	3-3-005-006	3/4"	1 1/16"	
	3-3-005-008	3/4"	1 5/16"	
	3-3-006-008	1"	1 5/16"	
	3-3-007-009	1 1/4"	1 5/8"	
	3-3-008-009A	1 1/2"	1 7/8"	

	3-3-200A-00	1/8"	7/16"	ΓΩΝΙΑ ΒΑΣΕΩΣ ΙΝΤΣΑΣ ΜΕ ΚΟΝΤΡΑ ΠΑΞΙΜΑΔΙ 45* BSP-UNF
	3-3-200-00	1/4"	7/16"	
	3-3-200-01	1/4"	1/2"	
	3-3-200-02	1/4"	9/16"	
	3-3-202-02	3/8"	9/16"	
	3-3-202-04	3/8"	3/4"	
	3-3-203-04	1/2"	3/4"	
	3-3-203-05	1/2"	7/8"	
	3-3-205-06	3/4"	1 1/16"	
	3-3-205-08	3/4"	1 5/16"	
	3-3-206-08	1"	1 5/16"	
	3-3-207-09	1 1/4"	1 5/8"	

	3-3-300A-00	1/8"	7/16"	ΓΩΝΙΑ ΒΑΣΕΩΣ ΙΝΤΣΑΣ ΜΕ ΚΟΝΤΡΑ ΠΑΞΙΜΑΔΙ 90* UNF
	3-3-300A-01	1/8"	1/2"	
	3-3-300-00	1/4"	7/16"	
	3-3-300-01	1/4"	1/2"	
	3-3-300-02	1/4"	9/16"	
	3-3-302-02	3/8"	9/16"	
	3-3-302-04	3/8"	3/4"	
	3-3-302-05	3/8"	7/8"	
	3-3-303-04	1/2"	3/4"	
	3-3-303-05	1/2"	7/8"	
	3-3-305-06	3/4"	1 1/16"	
	3-3-305-08	3/4"	1 5/16"	
	3-3-306-08	1"	1 5/16"	
3-3-307-09	1 1/4"	1 5/8"		

ΑΝΟΔΟΣ- ΔΗΜ Ι ΣΟΥΑΝΗΣ

3-ΝΙΠΕΛ ΣΠΕΙΡΩΜΑ ΙΝΤΣΑΣ UNF

	ΚΩΔΙΚΟΣ	ΣΠΕΙΡ.ΒΑΣΗΣ	ΣΠΕΙΡΩΜΑ	
		NPT	UNF	
	3-3-110A-00	1/8"	7/16"	ΝΙΠΕΛ ΒΑΣΕΩΣ ΙΝΤΣΑΣ NPT-BSP
	3-3-110A-01	1/8"	1/2"	
	3-3-110-00	1/4"	7/16"	
	3-3-110-01	1/4"	1/2"	
	3-3-100-02	1/4"	9/16"	
	3-3-102-02	3/8"	9/16"	
	3-3-102-04	3/8"	3/4"	
	3-3-102-05	3/8"	7/8"	
	3-3-103-04	1/2"	3/4"	
	3-3-103-05	1/2"	7/8"	
	3-3-105-06	3/4"	1 1/16"	
	3-3-105-08	3/4"	1 5/16"	
	3-3-106-08	1"	1 5/16"	
3-3-107-09	1 1/4"	1 5/8"		

	3-3-210A-00	1/8"	7/16"	ΓΩΝΙΑ ΒΑΣΕΩΣ ΙΝΤΣΑΣ NPT-BSP 45*
	3-3-210A-01	1/8"	1/2"	
	3-3-210-00	1/4"	7/16"	
	3-3-210-01	1/4"	1/2"	
	3-3-210-02	1/4"	9/16"	
	3-3-212-02	3/8"	9/16"	
	3-3-212-04	3/8"	3/4"	
	3-3-212-05	3/8"	7/8"	
	3-3-213-04	1/2"	3/4"	
	3-3-213-05	1/2"	7/8"	
	3-3-215-06	3/4"	1 1/16"	
	3-3-215-08	3/4"	1 5/16"	
	3-3-216-08	1"	1 5/16"	
3-3-217-09	1 1/4"	1 5/8"		

	3-3-310A-00	1/8"	7/16"	ΓΩΝΙΑ ΒΑΣΕΩΣ ΙΝΤΣΑΣ NPT-BSP 90*
	3-3-310A-01	1/8"	1/2"	
	3-3-310-00	1/4"	7/16"	
	3-3-310-01	1/4"	1/2"	
	3-3-310-02	1/4"	9/16"	
	3-3-312-02	3/8"	9/16"	
	3-3-312-04	3/8"	3/4"	
	3-3-312-05	3/8"	7/8"	
	3-3-313-04	1/2"	3/4"	
	3-3-313-05	1/2"	7/8"	
	3-3-315-06	3/4"	1 1/16"	
	3-3-315-08	3/4"	1 5/16"	
	3-3-316-08	1"	1 5/16"	
3-3-317-09	1 1/4"	1 5/8"		

ΑΝΟΔΟΣ- ΔΗΜ Ι ΣΟΥΑΝΗΣ

3-ΝΙΠΕΛ ΣΠΕΙΡΩΜΑ ΙΝΤΣΑΣ ΟΡFS

	ΚΩΔΙΚΟΣ	ΣΠΕΙΡΩΜΑ	
	3-7-000	9/16"X18	ΝΙΠΕΛ ΟΡFS
	3-7-002	11/16"X16	
	3-7-003	13/16"X16	
	3-7-004	1"X14	
	3-7-005	1 3/16"X12	
	3-7-006	1 7/16"X12	
	3-7-006	1 11/16"X12	

	3-7-100	9/16"X18	ΝΙΠΕΛ ΠΙΝΑΚΟΣ ΟΡFS
	3-7-102	11/16"X16	
	3-7-103	13/16"X16	
	3-7-104	1"X14	
	3-7-105	1 3/16"X12	
	3-7-106	1 7/16"X12	
	3-7-107	1 11/16"X12	

	3-7-1000	9/16"X18	ΓΩΝΙΑ ΠΙΝΑΚΟΣ ΟΡFS
	3-7-1002	11/16"X16	
	3-7-1003	13/16"X16	
	3-7-1004	1"X14	
	3-7-1005	1 3/16"X12	
	3-7-1006	1 7/16"X12	
	3-7-1007	1 11/16"X12	

	3-7-0002	9/16"X18-11/16"X16	ΝΙΠΕΛ ΣΥΣΤΟΛΙΚΟ ΟΡFS
	3-7-0023	11/16"X16-13/16"X16	
	3-7-0034	13/16"X16-1"X14	
	3-7-0045	1"X14-1 3/16"X12	
	3-7-0056	1 3/16"X12-1 7/16"X12	
	3-7-0067	1 7/16"X12-1 11/16"X12	

	3-7-200	9/16"X18	ΓΩΝΙΑ ΑΡΣΕΝΙΚΟ-ΑΡΣΕΝΙΚΟ ΟΡFS 45*
	3-7-202	11/16"X16	
	3-7-203	13/16"X16	
	3-7-204	1"X14	
	3-7-205	1 3/16"X12	
	3-7-206	1 7/16"X12	
	3-7-207	1 11/16"X12	

	3-7-210	9/16"X18	ΓΩΝΙΑ ΑΡΣΕΝΙΚΟ-ΘΗΛΥΚΟ ΟΡFS 45*
	3-7-212	11/16"X16	
	3-7-213	13/16"X16	
	3-7-214	1"X14	
	3-7-215	1 3/16"X12	
	3-7-216	1 7/16"X12	
	3-7-217	1 11/16"X12	

ΑΝΟΔΟΣ- ΔΗΜ Ι ΣΟΥΑΝΗΣ

3-ΝΙΠΕΛ ΣΠΕΙΡΩΜΑ ΙΝΤΣΑΣ ΟΡFS

	ΚΩΔΙΚΟΣ	ΣΠΕΙΡΩΜΑ	ΓΩΝΙΑ
	3-7-300	9/16"X18	
3-7-302	11/16"X16		
3-7-303	13/16"X16		
3-7-304	1"X14		
3-7-305	1 3/16"X12		
3-7-305	1 7/16"X12		
3-7-306	1 11/16"X12		

	ΚΩΔΙΚΟΣ	ΣΠΕΙΡΩΜΑ	ΓΩΝΙΑ
	3-7-310	9/16"X18	
3-7-312	11/16"X16		
3-7-313	13/16"X16		
3-7-314	1"X14		
3-7-315	1 3/16"X12		
3-7-316	1 7/16"X12		
3-7-317	1 11/16"X12		



	ΚΩΔΙΚΟΣ	ΣΠΕΙΡΩΜΑ	ΤΑΦ
	3-7-030	9/16"X18	
3-7-032	11/16"X16		
3-7-033	13/16"X16		
3-7-034	1"X14		
3-7-035	1 3/16"X12		
3-7-036	1 7/16"X12		
3-7-037	1 11/16"X12		

	ΚΩΔΙΚΟΣ	ΣΠΕΙΡΩΜΑ	ΤΑΦ
	3-7-03010	9/16"X18	
3-7-03012	11/16"X16		
3-7-03013	13/16"X16		
3-7-03014	1"X14		
3-7-03015	1 3/16"X12		
3-7-03016	1 7/16"X12		
3-7-03017	2 7/16"X12		

	ΚΩΔΙΚΟΣ	ΣΠΕΙΡΩΜΑ	ΤΑΦ
	3-7-0300	9/16"X18	
3-7-0302	11/16"X16		
3-7-0303	13/16"X16		
3-7-0304	1"X14		
3-7-0305	1 3/16"X12		
3-7-0306	1 7/16"X12		
3-7-0307	1 11/16"X12		

ΑΝΟΔΟΣ- ΔΗΜ Ι ΣΟΥΑΝΗΣ

3-ΝΙΠΕΛ ΣΠΕΙΡΩΜΑ ΙΝΤΣΑΣ ORFS

	ΚΩΔΙΚΟΣ	ΣΠΕΙΡ.ΒΑΣΗΣ	ΣΠΕΙΡΩΜΑ	
	3-7-200A-00	1/8"	9/16"X18	ΝΙΠΕΛ ΒΑΣΕΩΣ ΙΝΤΣΑΣ ΑΡΣΕΝΙΚΟ-ΑΡΣΕΝΙΚΟ BSP-ORFS
	3-7-200-00	1/4"	9/16"X18	
	3-7-200-02	1/4"	11/16"X16	
	3-7-202-02	3/8"	11/16"X16	
	3-7-202-03	3/8"	13/16"X16	
	3-7-202-04	3/8"	1"X14	
	3-7-203-04	1/2"	1"X14	
	3-7-205-05	3/4"	1 3/16"X12	
	3-7-205-06	3/4"	1 7/16"X12	
	3-7-206-06	1"	1 7/16"X12	
	3-7-220A-00	1/8"	9/16"X18	ΓΩΝΙΑ ΒΑΣΕΩΣ ΙΝΤΣΑΣ ΜΕ ΚΟΝΤΡΑ ΠΑΞΙΜΑΔΙ 45* ORFS
	3-7-220-00	1/4"	9/16"X18	
	3-7-220-02	1/4"	11/16"X16	
	3-7-222-02	3/8"	11/16"X16	
	3-7-222-03	3/8"	13/16"X16	
	3-7-222-04	3/8"	1"X14	
	3-7-223-04	1/2"	1"X14	
	3-7-225-05	3/4"	1 3/16"X12	
	3-7-225-06	3/4"	1 7/16"X12	
	3-7-226-06	1"	1 7/16"X12	
	3-7-300A-00	1/8"	9/16"X18	ΓΩΝΙΑ ΒΑΣΕΩΣ ΙΝΤΣΑΣ ΜΕ ΚΟΝΤΡΑ ΠΑΞΙΜΑΔΙ 90* ORFS
	3-7-300-00	1/4"	9/16"X18	
	3-7-300-02	1/4"	11/16"X16	
	3-7-302-02	3/8"	11/16"X16	
	3-7-302-03	3/8"	13/16"X16	
	3-7-302-04	3/8"	1"X14	
	3-7-303-04	1/2"	1"X14	
	3-7-305-05	3/4"	1 3/16"X12	
	3-7-305-06	3/4"	1 7/16"X12	
	3-7-306-06	1"	1 7/16"X12	
	3-7-210A-00	1/8"	9/16"X18	ΓΩΝΙΑ ΒΑΣΕΩΣ ΙΝΤΣΑΣ NPT-BSP 45*
	3-7-210-00	1/4"	9/16"X18	
	3-7-210-02	1/4"	11/16"X16	
	3-7-212-02	3/8"	11/16"X16	
	3-7-212-03	3/8"	13/16"X16	
	3-7-212-04	3/8"	1"X14	
	3-7-213-04	1/2"	1"X14	
	3-7-215-05	3/4"	1 3/16"X12	
	3-7-215-06	3/4"	1 7/16"X12	
	3-7-216-06	1"	1 7/16"X12	
	3-7-310A-00	1/8"	9/16"X18	ΓΩΝΙΑ ΒΑΣΕΩΣ ΙΝΤΣΑΣ NPT-BSP 90*
	3-7-310-00	1/4"	9/16"X18	
	3-7-310-02	1/4"	11/16"X16	
	3-7-312-02	3/8"	11/16"X16	
	3-7-312-03	3/8"	13/16"X16	
	3-7-312-04	3/8"	1"X14	
	3-7-313-04	1/2"	1"X14	
	3-7-315-05	3/4"	1 3/16"X12	
	3-7-315-06	3/4"	1 7/16"X12	
	3-7-316-06	1"	1 7/16"X12	

ΑΝΟΔΟΣ- ΔΗΜ Ι ΣΟΥΑΝΗΣ

4-ΤΑΠΕΣ ΕΛΑΙΟΥ (ΙΝΤΣΑΣ-ΜΕΤΡΙΚΟ)

	ΚΩΔΙΚΟΣ	ΣΠΕΙΡΩΜΑ	
	4-1-200A	1/8"	ΤΑΠΑ BSP ΘΗΛΥΚΗ
	4-1-200	1/4"	
	4-1-202	3/8"	
	4-1-203	1/2"	
	4-1-204	5/8"	
	4-1-205	3/4"	
	4-1-206	1"	
	4-1-207	1 1/4"	
	4-1-208	1 1/2"	
	4-1-209	2"	

	4-1-100A	1/8"	ΤΑΠΑ BSP ΑΡΣΕΝΙΚΗ
	4-1-100	1/4"	
	4-1-102	3/8"	
	4-1-103	1/2"	
	4-1-104	5/8"	
	4-1-105	3/4"	
	4-1-106	1"	
	4-1-107	1 1/4"	
	4-1-108	1 1/2"	
	4-1-109	2"	

	4-1-100A-10	1/8"	ΤΑΠΑ BSP ΑΡΣΕΝΙΚΗ ALLEN
	4-1-100-10	1/4"	
	4-1-102-10	3/8"	
	4-1-103-10	1/2"	
	4-1-104-10	5/8"	
	4-1-105-10	3/4"	
	4-1-106-10	1"	

	4-1-100A-1	1/8"	ΤΑΠΑ BSPT ΑΡΣΕΝΙΚΗ ALLEN ΑΚΕΦΑΛΗ
	4-1-100-1	1/4"	
	4-1-102-1	3/8"	
	4-1-103-1	1/2"	
	4-1-104-1	5/8"	
	4-1-105-1	3/4"	
	4-1-106-1	1"	

ΑΝΟΔΟΣ- ΔΗΜ Ι ΣΟΥΑΝΗΣ

4-ΤΑΠΕΣ ΕΛΑΙΟΥ (ΙΝΤΣΑΣ-ΜΕΤΡΙΚΟ)

	ΚΩΔΙΚΟΣ	ΣΠΕΙΡΩΜΑ		ΤΑΠΑ ΜΕΤΡΙΚΗ ΘΗΛΥΚΗ ΚΟΜΠΛΕ ΜΑΖΙ ΜΕ ΠΑΞΙΜΑΔΙ
	4-20-005	10X1	5LL	
	4-20-006	12X1,5	6L	
	4-20-008	14X1,5	8L	
	4-20-010	16X1,5	10L	
	4-20-012	18X1,5	12L	
	4-20-012S	20X1,5	12S	
	4-20-015	22X1,5	15L	
	4-20-016	24X1,5	16S	
	4-20-018	26X1,5	18L	
	4-20-020	30X2	20S	
	4-20-022	30X2	22L	
	4-20-025	36X2	25S	
	4-20-028	36X2	28L	
	4-20-030	42X2	30S	
	4-20-035	45X2	35L	
	4-20-038	52X2	38S	

	ΚΩΔΙΚΟΣ	ΣΠΕΙΡΩΜΑ		ΤΑΠΑ ΜΕΤΡΙΚΗ ΑΡΣΕΝΙΚΗ
	4-2-005	10X1	5LL	
	4-2-006	12X1,5	6L	
	4-2-008	14X1,5	8L	
	4-2-010	16X1,5	10L	
	4-2-012	18X1,5	12L	
	4-2-012S	20X1,5	12S	
	4-2-015	22X1,5	15L	
	4-2-016	24X1,5	16S	
	4-2-018	26X1,5	18L	
	4-2-020	30X2	20S	
	4-2-022	30X2	22L	
	4-2-025	36X2	25S	
	4-2-028	36X2	28L	
	4-2-030	42X2	30S	
	4-2-035	45X2	35L	
	4-2-038	52X2	38S	

ΑΝΟΔΟΣ- ΔΗΜ Ι ΣΟΥΑΝΗΣ

4-ΤΑΠΕΣ ΕΛΑΙΟΥ (ΙΝΤΣΑΣ-ΜΕΤΡΙΚΟ)

	ΚΩΔΙΚΟΣ	ΣΠΕΙΡΩΜΑ	
	4-3-000	7/16"	ΤΑΠΑ UNF ΘΗΛΥΚΗ
	4-3-001	1/2"	
	4-3-002	9/16"	
	4-3-003A	5/8"	
	4-3-003	3/4"	
	4-3-004	7/8"	
	4-3-005	1 1/16"	
	4-3-006	1 3/16"	
	4-3-007	1 5/16"	
	4-3-008	1 5/8"	
4-3-009	1 7/8"		

	4-3-100	7/16"	ΤΑΠΑ UNF ΑΡΣΕΝΙΚΗ
	4-3-101	1/2"	
	4-3-102	9/16"	
	4-3-103A	5/8"	
	4-3-103	3/4"	
	4-3-104	7/8"	
	4-3-105	1 1/16"	
	4-3-106	1 3/16"	
	4-3-107	1 5/16"	
	4-3-108	1 5/8"	
4-3-109	1 7/8"		

	4-7-000	9/16"X18	ΤΑΠΑ ORFS ΘΗΛΥΚΗ
	4-7-002	11/16"X16	
	4-7-003	13/16"X16	
	4-7-004	1"X14	
	4-7-005	1 3/16"X12	
	4-7-006	1 7/16"X12	
	4-7-007	1 11/16"X12	

	4-7-100	9/16"X18	ΤΑΠΑ ORFS ΑΡΣΕΝΙΚΗ
	4-7-102	11/16"X16	
	4-7-103	13/16"X16	
	4-7-104	1"X14	
	4-7-105	1 3/16"X12	
	4-7-106	1 7/16"X12	
	4-7-107	1 11/16"X12	

ΑΝΟΔΟΣ- ΔΗΜ Ι ΣΟΥΑΝΗΣ

3-ΡΑΚΟΡ ΚΟΛΛΗΤΑ

	ΚΩΔΙΚΟΣ	ΣΠΕΙΡΩΜΑ	
	3-1-04000-0	1/4"	ΜΟΥΦΑ ΚΟΛΛΗΤΗ ΙΝΤΣΑΣ
	3-1-04002-0	3/8"	
	3-1-04003-0	1/2"	
	3-1-04004-0	5/8"	
	3-1-04005-0	3/4"	
	3-1-04006-0	1"	

	ΚΩΔΙΚΟΣ	ΣΠΕΙΡΩΜΑ		
	3-2-100-4-0	8X1	4LL	ΡΑΚΟΡ ΚΟΛΛΗΤΟ ΜΕΤΡΙΚΑ
	3-2-100-5-0	10X1	5LL	
	3-2-100-6-0	12X1,5	6L	
	3-2-100-8-0	14X1,5	8L	
	3-2-100-10-0	16X1,5	10L	
	3-2-100-12-0	18X1,5	12L	
	3-2-100-12S-0	20X1,5	12S	
	3-2-100-15-0	22X1,5	15L	
	3-2-100-16-0	24X1,5	16S	
	3-2-100-18-0	26X1,5	18L	

ΑΝΟΔΟΣ- ΔΗΜ Ι ΣΟΥΑΝΗΣ

4-ΛΑΔΟΒΙΔΕΣ (ΙΝΤΣΑΣ-ΜΕΤΡΙΚΟ)

	ΚΩΔΙΚΟΣ	ΣΠΕΙΡΩΜΑ	
	4-1-300	1/4"	ΛΑΔΟΒΙΔΑ ΙΝΤΣΑΣ ΜΟΝΗ
	4-1-302	3/8"	
	4-1-303	1/2"	
	4-1-305	3/4"	
	4-1-306	1"	

	4-1-300Δ	1/4"	ΛΑΔΟΒΙΔΑ ΙΝΤΣΑΣ ΔΙΠΛΗ
	4-1-302Δ	3/8"	
	4-1-303Δ	1/2"	
	4-1-305Δ	3/4"	
	4-1-306Δ	1"	

	4-2-306-1	6X1	ΛΑΔΟΒΙΔΑ ΜΕΤΡΙΚΟ ΜΟΝΗ
	4-2-308-1	8X1	
	4-2-308-1,25	8X1,25	
	4-2-310-1	10X1	
	4-2-310-1,25	10X1,25	
	4-2-310-1,5	10X1,5	
	4-2-312-1	12X1	
	4-2-312-1,5	12X1,5	
	4-2-314-1,5	14X1,5	
	4-2-316-1,5	16X1,5	
	4-2-318-1,5	18X1,5	
	4-2-320-1,5	20X1,5	
	4-2-322-1,5	22X1,5	
	4-2-324-1,5	24X1,5	
	4-2-326-1,5	26X1,5	
4-2-330-1,5	30X1,5		

	4-2-308-1Δ	8X1	ΛΑΔΟΒΙΔΑ ΜΕΤΡΙΚΟ ΔΙΠΛΗ
	4-2-308-1,25Δ	8X1,25	
	4-2-310-1Δ	10X1	
	4-2-310-1,25Δ	10X1,25	
	4-2-310-1,5Δ	10X1,5	
	4-2-312-1Δ	12X1	
	4-2-312-1,5Δ	12X1,5	
	4-2-314-1,5Δ	14X1,5	
	4-2-316-1,5Δ	16X1,5	
	4-2-318-1,5Δ	18X1,5	
	4-2-320-1,5Δ	20X1,5	
	4-2-322-1,5Δ	22X1,5	
	4-2-324-1,5Δ	24X1,5	
	4-2-326-1,5Δ	26X1,5	
	4-2-330-1,5Δ	30X1,5	

ΑΝΟΔΟΣ- ΔΗΜ Ι ΣΟΥΑΝΗΣ

5-ΡΑΚΟΡ ΧΕΙΡΟΠΡΕΣΣΑΣ (ΙΝΤΣΑ-ΜΕΤΡΙΚΟ-ΣΟΥΗΔΙΚΟ)

	ΚΩΔΙΚΟΣ	ΔΙΑΣ.ΣΩΛΗΝΑ	ΣΠΕΙΡΩΜΑ	
	5-1-000A	1/4"	1/4"	ΡΑΚΟΡ ΧΕΙΡΟΠΡΕΣΣΑΣ ΘΗΛΥΚΟ ΙΝΤΣΑ
	5-1-000B	1/4"	3/8"	
	5-1-001A	5/16"	3/8"	
	5-1-002	3/8"	3/8"	
	5-1-003	1/2"	1/2"	
	5-1-005	3/4"	3/4"	
	5-1-006	1"	1"	

	5-1-100A	1/4"	1/8"	ΡΑΚΟΡ ΧΕΙΡΟΠΡΕΣΣΑΣ ΑΡΣΕΝΙΚΟ ΙΝΤΣΑ
	5-1-100	1/4"	1/4"	
	5-1-100B	1/4"	3/8"	
	5-1-101	5/16"	1/4"	
	5-1-101A	5/16"	3/8"	
	5-1-101B	5/16"	1/2"	
	5-1-102	3/8"	3/8"	
	5-1-102B	3/8"	1/2"	
	5-1-103A	1/2"	3/8"	
	5-1-103	1/2"	1/2"	
	5-1-105	3/4"	3/4"	
	5-1-106	1"	1"	

	5-2-000A	1/4"	10X1	ΡΑΚΟΡ ΧΕΙΡΟΠΡΕΣΣΑΣ ΘΗΛΥΚΟ ΜΕΤΡΙΚΟ
	5-2-000	1/4"	12X1,5	
	5-2-001	5/16"	14X1,5	
	5-2-001A	5/16"	16X1,5	
	5-2-002A	3/8"	16X1,5	
	5-2-002	3/8"	18X1,5	
	5-2-003	1/2"	22X1,5	
	5-2-004	5/8"	22X1,5	
	5-2-004A	5/8"	26X1,5	
	5-2-005	3/4"	26X1,5	

	5-2-100A	1/4"	10X1	ΡΑΚΟΡ ΧΕΙΡΟΠΡΕΣΣΑΣ ΑΡΣΕΝΙΚΟ ΜΕΤΡΙΚΟ
	5-2-100	1/4"	12X1,5	
	5-2-101	5/16"	14X1,5	
	5-2-101A	5/16"	16X1,5	
	5-2-102A	3/8"	16X1,5	
	5-2-102	3/8"	18X1,5	
	5-2-103	1/2"	22X1,5	
	5-2-104	5/8"	22X1,5	
	5-2-104A	5/8"	26X1,5	
	5-2-105	3/4"	26X1,5	

ΑΝΟΔΟΣ- ΔΗΜ Ι ΣΟΥΑΝΗΣ

5-ΡΑΚΟΡ SCANIA-VOLVO - ΡΑΚΟΡ ΚΟΜΦΛΕΡ

	ΚΩΔΙΚΟΣ	ΔΙΑΣ.ΣΩΛΗΝΑ	ΣΠΕΙΡΩΜΑ	
	5-4-002-1	3/8"	17/32"	ΣΟΥΗΔΙΚΟ ΡΑΚΟΡ ΧΕΙΡΟΠΡΕΣΣΑΣ ΘΗΛΥΚΟ
	5-4-002-2	3/8"	11/16"	
	5-4-003-1	1/2"	11/16"	
	5-4-003-2	1/2"	13/16"	

	5-4-102-1	3/8"	17/32"	ΣΟΥΗΔΙΚΟ ΡΑΚΟΡ ΧΕΙΡΟΠΡΕΣΣΑΣ ΑΡΣΕΝΙΚΟ
	5-4-102-1M	3/8"	17/32"ΜΑΚΡΥ	
	5-4-102-2	3/8"	11/16"	
	5-4-102-2M	3/8"	11/16"ΜΑΚΡΥ	
	5-4-103-1	1/2"	11/16"	
	5-4-103-1M	1/2"	11/16"ΜΑΚΡΥ	
	5-4-103-2	1/2"	13/16"	
	5-4-103-2M	1/2"	13/16"ΜΑΚΡΥ	

	5-2-013-22	1/2"	22X1,5	ΡΑΚΟΡ ΚΟΜΦΛΕΡ ΘΗΛΥΚΟ
	5-2-013-26	1/2"	26X1,5	
	5-2-014-22	5/8"	22X1,5	
	5-2-014-26	5/8"	26X1,5	

	5-2-023-16	1/2"	16X1,5	ΡΑΚΟΡ ΚΟΜΦΛΕΡ ΑΡΣΕΝΙΚΟ
	5-2-023-22	1/2"	22X1,5	
	5-2-023-26	1/2"	26X1,5	
	5-2-024-22	5/8"	22X1,5	
	5-2-024-26	5/8"	26X1,5	

ΑΝΟΔΟΣ- ΔΗΜ Ι ΣΟΥΑΝΗΣ

5-ΡΑΚΟΡ - ΘΗΛΕΙΣ ΠΕΤΡΕΛΑΙΟΥ

	ΚΩΔΙΚΟΣ	ΔΙΑΣ.ΣΩΛΗΝΑ	ΘΗΛΕΙΑ	
	5-6-00A6	3/16"	6MM	ΘΗΛΕΙΑ (ΡΑΝΙΟ)
	5-6-00A8	3/16"	8MM	
	5-6-00A10	3/16"	10MM	
	5-6-000	1/4"	10MM	
	5-6-000A	1/4"	12MM	
	5-6-000B	1/4"	14MM	
	5-6-001	5/16"	12MM	
	5-6-001A	5/16"	14MM	
	5-6-002B	3/8"	12MM	
	5-6-002	3/8"	14MM	
	5-6-002A	3/8"	16MM	
	5-6-003	1/2"	16MM	







	5-6-00A6-Δ	3/16"	8MM	ΘΗΛΕΙΑ (ΡΑΝΙΟ) ΔΙΠΛΗ
	5-6-000-Δ	1/4"	10MM	
	5-6-001-Δ	5/16"	12MM	
	5-6-002-Δ	3/8"	14MM	

	5-6-010-8	6X1	8MM	ΘΗΛΕΙΑ (ΡΑΝΙΟ) ΠΛΑΣΤΙΚΟΣΩΛΗΝΑ
	5-6-010-10	6X1	10MM	
	5-6-010-12	6X1	12MM	
	5-6-010-14	6X1	14MM	
	5-6-011-10	8X1	10MM	
	5-6-011-12	8X1	12MM	
	5-6-011-14	8X1	14MM	
	5-6-012-12	10X1	12MM	
	5-6-012-14	10X1	14MM	
	5-6-013-14	12X1,5	14MM	
	5-6-013-16	12X1,5	16MM	

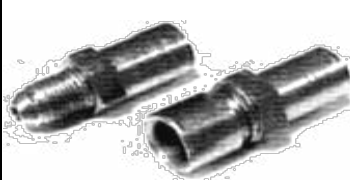
	7-1-0300D		1/4"	ΡΑΚΟΡ ΠΕΤΡΕΛΑΙΟΥ ΑΝΤΕΠΙΣΤΡΟΦΟ
	7-1-0301D		5/16"	
	7-1-0302D		3/8"	

ΑΝΟΔΟΣ- ΔΗΜ Ι ΣΟΥΑΝΗΣ

6-ΡΑΚΟΡ ΦΡΕΝΩΝ (ΥΔΡΑΥΛΙΚΗΣ ΠΡΕΣΣΑΣ - ΜΕΤΑΛΛΙΚΟΥ ΣΩΛΗΝΟΣ)

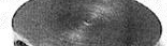
	ΚΩΔΙΚΟΣ	ΣΠΕΙΡΩΜΑ		
	6-6-002	3/8"X24	ΡΑΚΟΡ ΦΡΕΝΩΝ	
	6-6-003	1/2"X20	ΥΔΡΑΥΛΙΚΗΣ ΠΡΕΣΣΑΣ	
	6-6-004	5/8"X18	ΘΗΛΥΚΑ-ΙΝΤΣΑ	
	6-6-002-K	3/8"X24κωνικό	ΡΑΚΟΡ ΦΡΕΝΩΝ	
	6-6-002-ΙΣ	3/8"X24 λείο	ΥΔΡΑΥΛΙΚΗΣ ΠΡΕΣΣΑΣ	
	6-6-0012-K	7/16"X24 λείο		
	6-6-003-K	1/2"X20κωνικό	ΑΡΣΕΝΙΚΑ-ΙΝΤΣΑ	
	6-6-003-ΙΣ	1/2"X20 λείο		
	6-6-004-ΙΣ	5/8"X18 λείο		
	6-2-000-1	10X1	ΡΑΚΟΡ ΦΡΕΝΩΝ	
	6-2-000-1,25	10X1,25	ΥΔΡΑΥΛΙΚΗΣ ΠΡΕΣΣΑΣ	
	6-2-001-1	12X1	ΘΗΛΥΚΑ-ΜΕΤΡΙΚΟ	
	6-2-001-1,25	12X1,25		
	6-2-010-1	10X1	ΡΑΚΟΡ ΦΡΕΝΩΝ	
	6-2-010-1,25	10X1,25	ΥΔΡΑΥΛΙΚΗΣ ΠΡΕΣΣΑΣ	
	6-2-011-1	12X1	ΑΡΣΕΝΙΚΑ-ΜΕΤΡΙΚΟ	
	6-2-011-1.25	12X1,25		
	6-2-012-1	14X1		
	6-2-013-1,5	εσ.5/8"UNF 16X1,5		
	6-6-102	3/8"X24	ΡΑΚΟΡ ΦΡΕΝΩΝ	
	6-6-112	7/16"X24	ΜΕΤΑΛΙΚΗΣ	
	6-6-103	1/2"	ΣΩΛΗΝΑΣ	
	6-6-104	5/8"	ΙΝΤΣΑ	
	6-2-110A	8X1	ΡΑΚΟΡ ΦΡΕΝΩΝ	
	6-2-110-1	10X1	ΜΕΤΑΛΙΚΗΣ	
	6-2-110-1,25	10X1,25	ΣΩΛΗΝΑΣ	
	6-2-111-1	12X1	ΜΕΤΡΙΚΟ	
	6-2-111-1,25	12X1,25		
	6-2-112-1	14X1		
ΦΡΕΖΑ				
	6-2-40-1	10X1	ΑΡΣ. - ΘΗΛ.	ΜΟΥΦΑ ΦΡΕΝΩΝ
	6-2-40-1,25	10X1,25	ΑΡΣ. - ΘΗΛ.	
	6-2-41-1	12X1	ΑΡΣ. - ΘΗΛ.	ΜΕΤΡΙΚΟ
6-1-42-0	3/8"X24	ΑΡΣ. - ΘΗΛ.	ΙΝΤΣΑΣ	
	6-2-400-1	10X1	ΑΡΣ. - ΘΗΛ.	ΤΑΦ ΦΡΕΝΩΝ
	6-2-400-1,25	10X1,25	ΑΡΣ. - ΘΗΛ.	
	6-2-401-1	12X1	ΑΡΣ. - ΘΗΛ.	ΜΕΤΡΙΚΟ
6-1-420-0	3/8"X24	ΑΡΣ. - ΘΗΛ.	ΙΝΤΣΑΣ	

ΑΝΟΔΟΣ- ΔΗΜ Ι ΣΟΥΑΝΗΣ

ΥΔ-Χ-ΥΔΡΑΥΛΙΚΟ ΧΕΙΡΙΣΤΗΡΙΟ

ΚΩΔΙΚΟΣ	ΠΙΕΣΗ (BAR)	ΛΕΒΙΕ	
	ΥΔ-Χ-123-1	280/40	1 ΛΕΒΙΕ
	ΥΔ-Χ-123-2	280/40	2 ΛΕΒΙΕ
	ΥΔ-Χ-123-3	280/40	3 ΛΕΒΙΕ
	ΥΔ-Χ-123-4	280/40	4 ΛΕΒΙΕ
	ΥΔ-Χ-123-5	280/40	5 ΛΕΒΙΕ
	ΥΔ-Χ-123-6	280/40	6 ΛΕΒΙΕ
			ΥΔΡΑΥΛΙΚΟ ΧΕΙΡΙΣΤΗΡΙΟ
			P-T 1/2"
			A-B 3/8"
			320BAR-45LT
	ΥΔ-Χ-135-1	280/80	1 ΛΕΒΙΕ
	ΥΔ-Χ-135-2	280/80	2 ΛΕΒΙΕ
	ΥΔ-Χ-135-3	280/80	3 ΛΕΒΙΕ
	ΥΔ-Χ-135-4	280/80	4 ΛΕΒΙΕ
	ΥΔ-Χ-135-5	280/80	5 ΛΕΒΙΕ
	ΥΔ-Χ-135-6	280/80	6 ΛΕΒΙΕ
			ΥΔΡΑΥΛΙΚΟ ΧΕΙΡΙΣΤΗΡΙΟ
			P 3/4" T 1/2"
			A-B 1/2"
			280BAR-80LT
	ΥΔ-Χ-00	ΜΟΝΗΣ ΕΝΕΡΓΕΙΑΣ 25 LT	ΦΛΟΓΕΡΑ
	ΥΔ-Χ-02	ΜΟΝΗΣ ΕΝΕΡΓΕΙΑΣ 45 LT	ΜΟΝΗΣ ΕΝΕΡΓΕΙΑΣ
	ΥΔ-Χ-03	ΜΟΝΗΣ ΕΝΕΡΓΕΙΑΣ 80 LT	
	ΥΔ-Χ-10	ΔΙΠΛΗΣ ΕΝΕΡΓΕΙΑΣ 25 LT	ΦΛΟΓΕΡΑ
	ΥΔ-Χ-12	ΔΙΠΛΗΣ ΕΝΕΡΓΕΙΑΣ 45 LT	ΔΙΠΛΗΣ ΕΝΕΡΓΕΙΑΣ
	ΥΔ-Χ-13	ΔΙΠΛΗΣ ΕΝΕΡΓΕΙΑΣ 80 LT	
	ΥΔ-Χ-000	ΚΟΥΜΠΩΤΟΣ ΚΕΡΣΟΡΑΣ 25 LT	ΚΟΥΜΠΩΜΑ
	ΥΔ-Χ-002	ΚΟΥΜΠΩΤΟΣ ΚΕΡΣΟΡΑΣ 45 LT	
	ΥΔ-Χ-003	ΚΟΥΜΠΩΤΟΣ ΚΕΡΣΟΡΑΣ 80 LT	
	ΥΔ-Χ-0000	CARRY OVER 25 LT	CARRY OVER
	ΥΔ-Χ-0002	CARRY OVER 45 LT	
	ΥΔ-Χ-0003	CARRY OVER 80 LT	
	ΥΔ-Χ-0010	ΚΛΕΙΣΤΟ ΚΕΝΤΡΟ 25 LT	ΚΛΕΙΣΤΟ ΚΕΝΤΡΟ
	ΥΔ-Χ-0012	ΚΛΕΙΣΤΟ ΚΕΝΤΡΟ 45 LT	
	ΥΔ-Χ-0013	ΚΛΕΙΣΤΟ ΚΕΝΤΡΟ 80 LT	
	ΥΔ-Χ-00220	ΜΠΡΟΣΤΑ ΚΙΤ 45LT	ΜΠΡΟΣΤΑ ΚΙΤ
	ΥΔ-Χ-00230	ΜΠΡΟΣΤΑ ΚΙΤ 80LT	
	ΥΔ-Χ-10-0000	ΠΝΕΥΜΑΤΙΚΗ ΕΝΤΟΛΗ 1/4"	ΠΝΕΥΜΑΤΙΚΗ ΕΝΤΟΛΗ 1/4"
	ΥΔ-Χ-0022	JOYSTICK ΣΤΑΥΡΩΤΟ 3/8"	JOYSTICK ΣΤΑΥΡΩΤΟ
	ΥΔ-Χ-0023	JOYSTICK ΣΤΑΥΡΩΤΟ 1/2"	

ΑΝΟΔΟΣ- ΔΗΜ Ι ΣΟΥΑΝΗΣ

7-ΒΑΛΒΙΔΕΣ ΑΣΦΑΛΕΙΑΣ (ΜΟΝΟ-ΔΙΠΛΟ ΦΡΕΝΟ) - ΡΥΘΜΙΣΤΕΣ ΠΙΕΣΗΣ

	ΚΩΔΙΚΟΣ	ΔΙΑΣΤΑΣΗ	
	7-1-100	1/4"	ΔΙΠΛΗΣ ΕΝΕΡΓΕΙΑΣ ΔΙΠΛΟΥ ΚΛΕΙΔΩΜΑΤΟΣ
	7-1-102	3/8"	
	7-1-103	1/2"	
	7-1-105	3/4"	

	7-2-100	1/4"-12L	ΔΙΠΛΗΣ ΕΝΕΡΓΕΙΑΣ ΔΙΠΛΟΥ ΚΛΕΙΔΩΜΑΤΟΣ
	7-2-102	3/8"-12L	
	7-2-103	1/2"-15L	

	7-1-110	1/4"	ΔΙΠΛΗΣ ΕΝΕΡΓΕΙΑΣ ΜΕ ΈΝΑ ΦΡΕΝΟ
	7-1-112	3/8"	
	7-1-113	1/2"	
	7-1-115	3/4"	

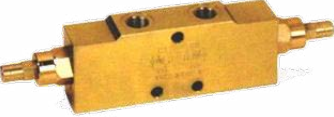
	7-1-120	1/4"	ΔΙΠΛΗΣ ΕΝΕΡΓΕΙΑΣ ΜΕ ΔΥΟ ΦΡΕΝΑ
	7-1-122	3/8"	
	7-1-123	1/2"	
	7-1-125	3/4"	

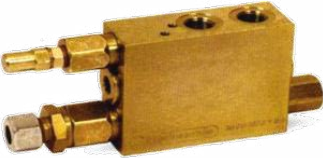
	7-1-AN-102	3/8"	ΑΝΑΣΤΡΟΦΗΣ	ΑΝΑΣΤΡΟΦΗΣ ΑΡΟΤΡΟΥ 80/100
---	------------	------	-------------------	--

	7-1-100-40	3/8"-12L	L= 40MM	ΘΗΛΕΙΑ ΜΠΟΥΚΑΛΑΣ
	7-1-100-106	3/8"-12L	L=106MM	
	7-1-100-199	3/8"-12L	L=199MM	
	7-1-100-300	3/8"-12L	L=300MM	
	7-1-100-400	3/8"-12L	L=400MM	
	7-1-100-500	3/8"-12L	L=500MM	

	7-1-100-12L	3/8"-12L	18X1,5-12L	ΘΗΛΕΙΑ ΜΠΟΥΚΑΛΑΣ
---	-------------	----------	------------	-----------------------------

ΑΝΟΔΟΣ- ΔΗΜ Ι ΣΟΥΑΝΗΣ

13-14-15-16-ΗΛΕΚΤΡΟΒΑΛΒΙΔΕΣ-ΜΟΤΕΡ-ΨΥΓΕΙΑ

ΚΩΔΙΚΟΣ

ΔΙΑΣΤΑΣΗ

	13-0-0000-100	ΥΔΡΑΥΛΙΚΑ ΨΥΓΕΙΑ
	13-0-0000-150	

	13-0-0003-OP50	ΜΟΤΕΡ
	13-0-0003-OP80	
	13-0-0003-OP125	
	13-0-0003-OP160	
	13-0-0003-OP250	

	14-0-002-1	ΤΑΚΟΣ ΥΔΡΑΥΛΙΚΟΣ
	14-0-002-2	
	14-0-002-3	
	14-0-002-4	
	14-0-002-5	
	14-0-002-6	

	14-0-002-06	ΗΛΕΚΤΡΟΒΑΝΑ ΕΞΑΟΔΗ
---	-------------	-------------------------------

	14-0-003-03	ΗΛΕΚΤΡΟΒΑΝΑ ΤΡΙΟΔΗ
---	-------------	-------------------------------

	15-0-0000-1	ΗΛΕΚΤΡΟΒΑΛΒΙΔΑ
---	-------------	-----------------------

	16-0-000-4	ΧΕΙΡΙΣΤΗΡΙΟ JOYSTICK
	16-0-000-6	
	16-0-000-8	

ΑΝΟΔΟΣ- ΔΗΜ Ι ΣΟΥΑΝΗΣ

7-ΒΑΛΒΙΔΕΣ ΑΣΦΑΛΕΙΑΣ - ΡΥΘΜΙΣΤΕΣ ΠΙΕΣΗΣ - ΑΝΤΑΠΤΟΡΕΣ ΠΕΡΙΣΤΡΕΦΟΜΕΝΟΙ

	ΚΩΔΙΚΟΣ	ΔΙΑΣΤΑΣΗ	
	7-1-300	1/4"	ΒΑΛΒΙΔΑ ΑΝΤΕΠΙΣΤΡΟΦΗΣ
	7-1-302	3/8"	
	7-1-303	1/2"	
	7-1-305	3/4"	
	7-1-306	1"	

	7-1-320	1/4"	ΒΑΛΒΙΔΑ ΘΡΑΥΣΕΩΣ ΑΛΕΞΙΠΤΩΤΟ
	7-1-322	3/8"	
	7-1-323	1/2"	
	7-1-325	3/4"	
	7-1-326	1"	

	7-1-200	1/4"	ΣΤΡΑΓΓΑΛΙΣΤΗΣ ΑΝΤΕΠΙΣΤΡΟΦΟΣ VRF
	7-1-202	3/8"	
	7-1-203	1/2"	
	7-1-205	3/4"	

	7-1-210	1/4"	ΣΤΡΑΓΓΑΛΙΣΤΗΣ ΑΜΦΙΔΡΟΜΟΣ VRB
	7-1-212	3/8"	
	7-1-213	1/2"	
	7-1-215	3/4"	

	7-1-220	1/4"	ΣΤΡΑΓΓΑΛΙΣΤΗΣ ΑΝΤΕΠΙΣΤΡΟΦΟΣ ΜΙΚΡΟΜΕΤΡΟ VRF
	7-1-222	3/8"	
	7-1-223	1/2"	
	7-1-225	3/4"	

	7-1-230	1/4"	ΣΤΡΑΓΓΑΛΙΣΤΗΣ ΑΜΦΙΔΡΟΜΟΣ ΜΙΚΡΟΜΕΤΡΟ VRB
	7-1-232	3/8"	
	7-1-233	1/2"	
	7-1-235	3/4"	

ΑΝΤΑΠΤΟΡΑΣ ΠΕΡΙΣΤΡΕΦΟΜΕΝΟΣ

	7-3-1-300	1/4"	ΠΕΡΙΣΤΡΕΦΟΜΕΝΟ ΑΡΣΕΝΙΚΟ-ΘΗΛΥΚΟ
	7-3-1-302	3/8"	
	7-3-1-303	1/2"	
	7-3-1-305	3/4"	
	7-3-1-306	1"	

	7-3-1-320	1/4"	ΠΕΡΙΣΤΡΕΦΟΜΕΝΑ ΓΩΝΙΑ
	7-3-1-322	3/8"	
	7-3-1-323	1/2"	
	7-3-1-325	3/4"	
	7-3-1-326	1"	

ΑΝΟΔΟΣ- ΔΗΜ Ι ΣΟΥΑΝΗΣ

7-ΒΑΛΒΙΔΕΣ ΑΣΦΑΛΕΙΑΣ (ΜΟΝΟ-ΔΙΠΛΟ ΦΡΕΝΟ) - ΡΥΘΜΙΣΤΕΣ ΠΙΕΣΗΣ

	ΚΩΔΙΚΟΣ	ΔΙΑΣΤΑΣΗ		
	7-1-8-102DX	3/8"	ΔΕΞΙ	ΒΑΛΒΙΔΑ ΑΣΦΑΛΕΙΑΣ ΠΟΔΑΡΙΚΟΥ ΔΙΠΛΟΥ ΚΛΕΙΔΩΜΑΤΟΣ
	7-1-8-102SX	3/8"	ΑΡΙΣΤΕΡΟ	
	7-1-8-103DX	1/2"	ΔΕΞΙ	
	7-1-8-103SX	1/2"	ΑΡΙΣΤΕΡΟ	

	7-1-402	3/8"		ΡΥΘΜΙΣΤΗΣ ΠΙΕΣΗΣ ΒΑΛΒΙΔΑ ΕΠΙΣΤΡΟΦΗΣ 50LT
	7-1-403	1/2"		
	7-1-405	3/4"		

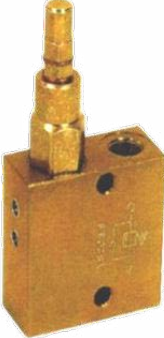
	7-1-502	3/8"		ΒΑΛΒΙΔΑ ΣΥΝΕΧΕΙΑΣ 3/8"
	ΑΦΟΥ ΠΛΗΡΩΘΕΙ Η ΠΡΩΤΗ ΜΠΟΥΚΑΛΑ ΣΥΝΕΧΙΖΕΙ ΣΤΗΝ ΙΔΙΑ ΠΙΕΣΗ ΠΡΟΚΕΙΜΕΝΟΥ ΝΑ ΓΕΜΙΣΕΙ Η ΕΠΟΜΕΝΗ.			

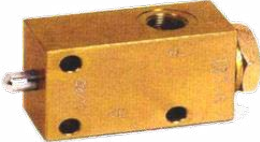
	7-1-602	3/8"-1/2"		ΤΕΡΜΑΤΙΚΟ ΑΝΑΤΡΟΠΗΣ
---	---------	-----------	--	--------------------------------

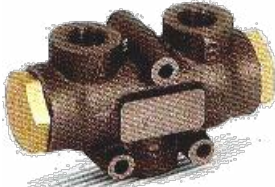
	7-1-702	3/8"-3/8"-1/2"		ΒΑΛΒΙΔΑ 50-50 ΧΑΛΥΒΔΙΝΗ
---	---------	----------------	--	--

ΑΝΟΔΟΣ- ΔΗΜ Ι ΣΟΥΑΝΗΣ

7-ΤΑΧΥΣΥΝΔΕΣΜΟΙ ΕΛΑΙΟΥ

	ΚΩΔΙΚΟΣ	ΔΙΑΣΤΑΣΗ	
	7-1-000	1/4"	ΤΑΧΥΣΥΝΔΕΣΜΟΣ ΕΛΑΙΟΥ
	7-1-002	3/8"	
	7-1-003	1/2"	
	7-1-005	3/4"	
	7-1-006	1"	
	7-1-007	1 1/4"	
	7-1-008	1 1/2"	
	7-1-009	2"	

	7-1-000A	1/4"	ΤΑΧΥΣΥΝΔΕΣΜΟΣ ΕΛΑΙΟΥ ΑΡΣΕΝΙΚΟΣ	
	7-1-002A	3/8"		
	7-1-003A	1/2"		
	7-1-033A	18X1,5		ΦΡΕΝΟΥ
	7-1-005A	3/4"		
	7-1-006A	1"		
	7-1-007A	1 1/4"		
	7-1-008A	1 1/2"		
	7-1-009A	2"		

	7-1-000Θ	1/4"	ΤΑΧΥΣΥΝΔΕΣΜΟΣ ΕΛΑΙΟΥ ΘΗΛΥΚΟΣ	
	7-1-002Θ	3/8"		
	7-1-003Θ	1/2"		
	7-1-0003Θ	1/2"		ΓΕΩΡΓ. ΤΥΠΟΥ
	7-1-033Θ	18X1,5		ΦΡΕΝΟΥ
	7-1-005Θ	3/4"		
	7-1-006Θ	1"		
	7-1-007Θ	1 1/4"		
	7-1-008Θ	1 1/2"		
7-1-009Θ	2"			

	7-1-003-A	1/2"	ΑΡΣΕΝΙΚΟ	ΠΡΟΣΤΑΤΕΥΤΙΚΟ ΤΑΧΥΣΥΝΔΕΣΜΟΣ ΕΛΑΙΟΥ
	7-1-003-Θ	1/2"	ΘΗΛΥΚΟ	

	7-1-010	1/4"	ΤΑΧΥΣΥΝΔΕΣΜΟΣ ΕΛΑΙΟΥ ΒΙΔΩΤΟΣ ΒΑΡΕΩΣ ΤΥΠΟΥ
	7-1-012	3/8"	
	7-1-013	1/2"	
	7-1-015	3/4"	
	7-1-016	1"	

	7-1-022	3/8"	ΤΑΧΥΣΥΝΔΕΣΜΟΣ ΕΛΑΙΟΥ FLAT FACE ΣΦΥΡΑΣ
	7-1-023	1/2"	
	7-1-025	3/4"	
	7-1-026	1"	

ΑΝΟΔΟΣ- ΔΗΜ Ι ΣΟΥΑΝΗΣ

8-BANES

	ΚΩΔΙΚΟΣ		ΔΙΑΣΤΑΣΗ	
	8-1-000	ΔΥΟΔΗ	1/4"	ΒΑΝΕΣ ΥΔΡΑΥΛΙΚΗΣ ΠΙΕΣΗΣ ΕΛΑΙΟΥ 400BAR ΔΥΟΔΗ
	8-1-002	ΔΥΟΔΗ	3/8"	
	8-1-003	ΔΥΟΔΗ	1/2"	
	8-1-005	ΔΥΟΔΗ	3/4"	
	8-1-006	ΔΥΟΔΗ	1"	
	8-1-007	ΔΥΟΔΗ	1 1/4"	
	8-1-008	ΔΥΟΔΗ	1 1/2"	
	8-1-009	ΔΥΟΔΗ	2"	

	8-1-010	ΤΡΙΟΔΗ	1/4"	ΒΑΝΕΣ ΥΔΡΑΥΛΙΚΗΣ ΠΙΕΣΗΣ ΕΛΑΙΟΥ 400BAR ΤΡΙΟΔΗ
	8-1-012	ΤΡΙΟΔΗ	3/8"	
	8-1-013	ΤΡΙΟΔΗ	1/2"	
	8-1-015	ΤΡΙΟΔΗ	3/4"	
	8-1-016	ΤΡΙΟΔΗ	1"	
	8-1-017	ΤΡΙΟΔΗ	1 1/4"	
	8-1-018	ΤΡΙΟΔΗ	1 1/2"	
	8-1-019	ΤΡΙΟΔΗ	2"	

	8-1-010-0	ΤΡΙΟΔΗ	1/4"	ΒΑΝΕΣ ΥΔΡΑΥΛΙΚΗΣ ΠΙΕΣΗΣ ΕΛΑΙΟΥ 400BAR ΧΕΙΡΙΣΤΗΡΙΟΥ
	8-1-012-0	ΤΡΙΟΔΗ	3/8"	
	8-1-013-0	ΤΡΙΟΔΗ	1/2"	
	8-1-015-0	ΤΡΙΟΔΗ	3/4"	





	8-1-020-0	ΤΕΤΡΑΟΔΗ	1/4"	ΒΑΝΕΣ ΥΔΡΑΥΛΙΚΗΣ ΠΙΕΣΗΣ ΕΛΑΙΟΥ ΤΕΤΡΑΟΔΗ ΧΕΙΡΙΣΤΗΡΙΟΥ
	8-1-022-0	ΤΕΤΡΑΟΔΗ	3/8"	
	8-1-023-0	ΤΕΤΡΑΟΔΗ	1/2"	
	8-1-025-0	ΤΕΤΡΑΟΔΗ	3/4"	

	8-1-012-6		3/8"	ΒΑΝΕΣ ΥΔΡΑΥΛΙΚΗΣ ΠΙΕΣΗΣ ΕΛΑΙΟΥ ΕΞΑΟΔΗ ΧΕΙΡΙΣΤΗΡΙΟΥ
	8-1-013-6		1/2"	

	8-1-013-NB		1/2"	ΒΑΝΕΣ ΝΕΡΟΥ ΒΑΡΕΩΣ ΤΥΠΟΥ
	8-1-015-NB		3/4"	
	8-1-016-NB		1"	
	8-1-017-NB		1 1/4"	
	8-1-018-NB		1 1/2"	
	8-1-019-NB		2"	
	8-1-019-ANB		2 1/2"	
	8-1-019-BNB		3"	
	8-1-019-CNB		4"	

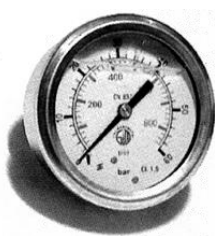
ΑΝΟΔΟΣ- ΔΗΜ Ι ΣΟΥΑΝΗΣ

ΜΝ-ΜΑΝΟΜΕΤΡΑ-ΕΞΑΡΤΗΜΑΤΑ ΜΑΝΟΜΕΤΡΩΝ

	ΚΩΔΙΚΟΣ	ΠΙΕΣΗ	
	MN-0001	-.1 - +3.	1/4" Φ63
	MN-0002	0-1	1/4" Φ63
	MN-0002A	0-1,6	1/4" Φ63
	MN-0002B	0-2,5	1/4" Φ63
	MN-0002C	0-4	1/4" Φ63
	MN-0002D	0-6	1/4" Φ63
	MN-0003	0-10	1/4" Φ63
	MN-0003A	0-16	1/4" Φ63
	MN-0004	0-25	1/4" Φ63
	MN-0005	0-40	1/4" Φ63
	MN-0006	0-60	1/4" Φ63
MN-0007	0-100	1/4" Φ63	
MN-0008	0-250	1/4" Φ63	
MN-0009	0-400	1/4" Φ63	
MN-0010	0-600	1/4" Φ63	
MN-0010A	0-1000	1/4"-Φ63	
	MN-0012C	0-4	1/4" Φ63
	MN-0012D	0-6	1/4" Φ63
	MN-0013	0-10	1/4" Φ63
	MN-0013A	0-16	1/4" Φ63
	MN-0014	0-25	1/4" Φ63
	MN-0015	0-40	1/4" Φ63
	MN-0016	0-60	1/4" Φ63
	MN-0017	0-100	1/4" Φ63
	MN-0018	0-250	1/4" Φ63
	MN-0018A	0-315	1/4" Φ63
MN-0019	0-400	1/4" Φ63	
	MN-00130	0-10	1/4" Φ63
	MN-00130A	0-16	1/4" Φ63
	MN-00140	0-25	1/4" Φ63
	MN-00150	0-40	1/4" Φ63
	MN-00160	0-60	1/4" Φ63
	MN-00170	0-100	1/4" Φ63
	MN-00180	0-250	1/4" Φ63
	MN-00180A	0-315	1/4" Φ63
	MN-00190	0-400	1/4" Φ63
		MN-0042D	0-6
MN-0043		0-10	1/4" Φ63
MN-0043A		0-16	1/4" Φ63
MN-0044		0-25	1/4" Φ63
MN-0045		0-40	1/4" Φ63
MN-0046		0-60	1/4" Φ63
MN-00043A		0-16	1/8" Φ40
MN-0053	0-10	1/4" Φ63	
MN-0053A	0-16	1/4" Φ63	
	MN-0000-63	ΒΑΣΗ ΜΑΝΟΜΕΤΡΟΥ Φ63	

**ΓΛΥΚΕΡΙΝΗΣ
ΚΑΤΩ ΒΑΣΗ
ΣΠΕΙΡΩΜΑ 1/4"
Φ63**

**ΓΛΥΚΕΡΙΝΗΣ
ΠΙΣΩ ΒΑΣΗ
ΣΠΕΙΡΩΜΑ 1/4"
Φ63**

**ΓΛΥΚΕΡΙΝΗΣ
ΠΙΣΩ ΒΑΣΗ
ΣΠΕΙΡΩΜΑ 1/4"
Φ63
ΦΛΑΝΤΖΩΤΟ**

**ΜΑΝΟΜΕΤΡΑ ΑΕΡΟΣ
ΚΑΤΩ ΒΑΣΗ
6-10-16-25-40-60
BAR**

**ΜΑΝΟΜΕΤΡΑ ΑΕΡΟΣ
ΠΙΣΩ ΒΑΣΗ**

ΒΑΣΗ ΜΑΝΟΜΕΤΡΟΥ

ΑΝΟΔΟΣ- ΔΗΜ Ι ΣΟΥΑΝΗΣ

ΜΝ-ΜΑΝΟΜΕΤΡΑ-ΕΞΑΡΤΗΜΑΤΑ ΜΑΝΟΜΕΤΡΩΝ

	ΚΩΔΙΚΟΣ	ΠΙΕΣΗ		
	MN-0022D	0-6	1/2" Φ100	ΓΛΥΚΕΡΙΝΗΣ ΚΑΤΩ ΒΑΣΗ ΣΠΕΙΡΩΜΑ 1/2" Φ100
	MN-0023	0-10	1/2" Φ100	
	MN-0003A	0-16	1/2" Φ100	
	MN-0024	0-25	1/2" Φ100	
	MN-0025	0-40	1/2" Φ100	
	MN-0026	0-60	1/2" Φ100	
	MN-0027	0-100	1/2" Φ100	
	MN-0028	0-250	1/2" Φ100	
	MN-0029	0-400	1/2" Φ100	

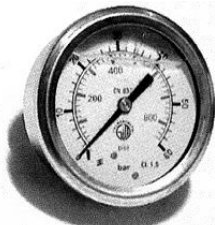
	ΚΩΔΙΚΟΣ	ΠΙΕΣΗ		
	MN-00220D	0-6	1/2" Φ100	ΓΛΥΚΕΡΙΝΗΣ ΠΙΣΩ ΒΑΣΗ ΣΠΕΙΡΩΜΑ 1/2" Φ100 ΦΛΑΝΤΖΩΤΟ
	MN-00230	0-10	1/2" Φ100	
	MN-00230A	0-16	1/2" Φ100	
	MN-00240	0-25	1/2" Φ100	
	MN-00250	0-40	1/2" Φ100	
	MN-00260	0-60	1/2" Φ100	
	MN-00270	0-100	1/2" Φ100	
	MN-00280	0-250	1/2" Φ100	
	MN-00280A	0-315	1/2" Φ100	
MN-00290	0-400	1/2" Φ100		

	ΚΩΔΙΚΟΣ	ΜΗΚΟΣ	ΣΠΕΙΡΩΜΑ	
	MN-0100	1,0m	16X2	ΣΩΛΗΝΑΣ ΜΕΤΡΗΣΗΣ ΠΙΕΣΗΣ ΑΚΡΑ 16X2
	MN-0101	1,5m	16X2	
	MN-0102	2,0m	16X2	
	MN-0103	2,5m	16X2	
	MN-0104	3,2m	16X2	
	MN-0105	4,0m	16X2	

	ΚΩΔΙΚΟΣ	ΜΗΚΟΣ	ΣΠΕΙΡΩΜΑ	
	MN-0200A	ΑΡΣΕΝΙΚΟ	1/8"	ΡΑΚΟΡ ΛΗΨΗΣ ΜΑΝΟΜΕΤΡΩΝ ΑΡΣΕΝΙΚΑ
	MN-0200	ΑΡΣΕΝΙΚΟ	1/4"	
	MN-0202	ΑΡΣΕΝΙΚΟ	3/8"	
	MN-0211	ΑΡΣΕΝΙΚΟ	12X1,5	
	MN-0212	ΑΡΣΕΝΙΚΟ	14X1,5	
	MN-0213	ΑΡΣΕΝΙΚΟ	16X1,5	

	ΚΩΔΙΚΟΣ	ΜΗΚΟΣ	ΣΠΕΙΡΩΜΑ	
	MN-0212S	ΘΗΛΥΚΟ	14X1,5S	ΡΑΚΟΡ ΛΗΨΗΣ ΜΑΝΟΜΕΤΡΩΝ ΘΗΛΥΚΑ
	MN-0213S	ΘΗΛΥΚΟ	16X1,5S	
	MN-0212L	ΘΗΛΥΚΟ	14X1,5L	
	MN-0213L	ΘΗΛΥΚΟ	16X1,5L	

	ΚΩΔΙΚΟΣ	ΜΗΚΟΣ	ΣΠΕΙΡΩΜΑ	
	MN-0300	ΣΤΑΘΕΡΟ	1/4"	ΡΑΚΟΡ ΛΗΨΗΣ ΜΑΝΟΜΕΤΡΩΝ ΠΙΝΑΚΟΣ

	ΚΩΔΙΚΟΣ	ΜΗΚΟΣ	ΣΠΕΙΡΩΜΑ	
	3-1-1000-6	1/4"	12X1,5-6L	
	3-1-1000-8	1/4"	14X1,5-8L	
	3-1-1000-10	1/4"	16X1,5-10L	
	3-1-1000-12	1/4"	18X1,5-12L	
	3-1-1003-15	1/2"	22X1,5-15L	







ΑΝΟΔΟΣ- ΔΗΜ Ι ΣΟΥΑΝΗΣ

9-ΕΞΑΡΤΗΜΑΤΑ ΠΛΥΣΤΙΚΩΝ ΜΗΧΑΝΗΜΑΤΩΝ

	ΚΩΔΙΚΟΣ	ΔΙΑΣΤΑΣΗ	
	9-2-2000-14	1/4"	22X1,5-14MM
	9-2-2001-14	5/16"	22X1,5-14MM
	9-2-2002-14	3/8"	22X1,5-14MM
	9-2-2000-15	1/4"	22X1,5-15MM
	9-2-2010-14	1/4"	21X1,5-14MM
	9-2-2011-14	5/16"	21X1,5-14MM
	9-2-2012-14	3/8"	21X1,5-14MM
	9-2-20000-14	1/4"	22X1,5-14MM
	9-2-20001-14	5/16"	22X1,5-14MM
	9-1-2000-10	1/4"	Φ10,5
	9-1-2001-10	5/16"	Φ10,5
	9-1-2010-10	1/4"	Φ10
	9-1-2011-11	5/16"	Φ11
	9-1-2000-8	1/4"	Φ8
	9-1-2020-11	1/4"	Φ11
	9-1-2030-11	1/4"	Φ11
	9-1-2040-11	1/4"	Φ11
	9-2-2050-00	1/4"	
	9-2-2051-00	5/16"	
	9-3-000-14	1/4"-22X1,5-Φ14	
	9-3-002-14	3/8"-22X1,5-Φ14	
	9-3-010-14	1/4"-22X1,5-Φ14	
	9-3-012-14	3/8"-22X1,5-Φ14	
	9-3-012-00	3/8"-21X1,5	
	9-3-000-00	22X1,5-22X1,5	
	9-3-000-014	1/4"-22X1,5	
	9-3-002-014	3/8"-22X1,5	
	9-3-000-0014	1/4"-22X1,5	
	9-3-002-0014	3/8"-22X1,5	

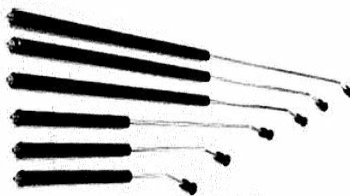
ΑΝΟΔΟΣ- ΔΗΜΙ ΣΟΥΑΝΗΣ

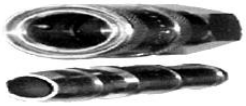
9-ΕΞΑΡΤΗΜΑΤΑ ΠΛΥΣΤΙΚΩΝ ΜΗΧΑΝΗΜΑΤΩΝ

	ΚΩΔΙΚΟΣ	ΔΙΑΣΤΑΣΗ		
	9-4-002	3/8"		ΠΙΣΤΟΛΙ ΠΛΥΣΤΙΚΗΣ ΜΕ ΠΙΣΩ ΡΥΘΜΙΣΗ
	9-4-0002	3/8"		ΠΙΣΤΟΛΙ ΠΛΥΣΤΙΚΗΣ ΛΑΝΤΖΑΣ
	9-4-0002-1	3/8"	ΠΕΡΙΣΤΡΟΦΙΚΟ	
	9-5-000-01	1/4"	L= 700MM	ΛΑΝΤΖΑ
	9-5-000-02	1/4"	L= 900MM	
	9-5-000-03	1/4"	L=1200MM	
	9-5-000-04	1/4"	L=1500MM	
	9-4-0012	3/8"	ΙΝΟΧ	ΠΙΣΤΟΛΙ ΑΦΡΟΠΟΙΗΤΗ
	9-6-000	1/4"		ΜΠΕΚ ΛΑΝΤΖΑΣ
	7-1-902Α	3/8"	ΑΡΣΕΝΙΚΟ	ΤΑΧΥΣΥΝΔΕΣΜΟΣ ΠΙΕΣΤΙΚΟΥ ΠΛΥΣΤΙΚΗΣ
	7-1-902Θ	3/8"	ΘΗΛΥΚΟ	
	9-7-000	1/4"		ΧΟΥΦΤΑ ΠΛΥΣΤΙΚΟΥ ΣΩΛΗΝΑ
	9-7-001	5/16"		
	9-7-002	3/8"		

ΑΝΟΔΟΣ- ΔΗΜ Ι ΣΟΥΑΝΗΣ

10-ΡΑΚΟΡ ΑΕΡΟΣ

	ΚΩΔΙΚΟΣ	ΔΙΑΣΤΑΣΗ	
	10-10-1000A-6	1/8"-Φ6	ΡΑΚΟΡ ΑΕΡΟΣ ΘΗΛΥΚΟ ΣΤΑΘΕΡΟ
	10-10-1000-6	1/4"-Φ6	
	10-10-1000-8	1/4"-Φ8	
	10-10-1000-10	1/4"-Φ10	
	10-10-1000-12	1/4"-Φ12	
	10-10-1002-10	3/8"-Φ10	
	10-10-1003-10	1/2"-Φ10	
	10-10-1003-12	1/2"-Φ12	

	10-10-1100A-6	1/8"-Φ6	ΡΑΚΟΡ ΑΕΡΟΣ ΑΡΣΕΝΙΚΟ
	10-10-1100-6	1/4"-Φ6	
	10-10-1100-8	1/4"-Φ8	
	10-10-1100-10	1/4"-Φ10	
	10-10-1100-12	1/4"-Φ12	
	10-10-1102-8	3/8"-Φ8	
	10-10-1102-10	3/8"-Φ10	
	10-10-1102-12	3/8"-Φ12	
	10-10-1103-10	1/2"-Φ10	
	10-10-1103-12	1/2"-Φ12	
	10-10-1103-16	1/2"-Φ16	

	10-10-9100A	ΣΩΛΗΝΑ Φ6	4MM	ΔΙΠΛΗ ΣΥΝΔΕΣΗ
	10-10-9100.	ΣΩΛΗΝΑ Φ8	6MM	
	10-10-9101.	ΣΩΛΗΝΑ Φ10	8MM	
	10-10-9002.	ΣΩΛΗΝΑ Φ12	10MM	

ΑΝΟΔΟΣ- ΔΗΜΙ ΣΟΥΑΝΗΣ

10-ΕΞΑΡΤΗΜΑΤΑ ΑΕΡΟΣ

	ΚΩΔΙΚΟΣ	ΔΙΑΣΤΑΣΗ	
	10-000-4	Φ4	ΑΥΤΟΜΑΤΟΣ ΜΕΤΑΛΛΙΚΟΣ ΣΥΝΔΕΣΜΟΣ ΑΕΡΟΣ ΙΣΙΟ
	10-000-5	Φ5	
	10-000-6	Φ6	
	10-000-8	Φ8	
	10-000-9	Φ9	
	10-000-10	Φ10	
	10-000-11	Φ11	
	10-000-12	Φ12	
	10-000-14	Φ14	
	10-000-16	Φ16	

	ΚΩΔΙΚΟΣ	ΔΙΑΣΤΑΣΗ	
	10-200-4	Φ4	ΑΥΤΟΜΑΤΟΣ ΜΕΤΑΛΛΙΚΟΣ ΣΥΝΔΕΣΜΟΣ ΑΕΡΟΣ ΓΩΝΙΑ
	10-200-5	Φ5	
	10-200-6	Φ6	
	10-200-8	Φ8	
	10-200-9	Φ9	
	10-200-10	Φ10	
	10-200-11	Φ11	
	10-200-12	Φ12	
	10-200-14	Φ14	
	10-200-16	Φ16	

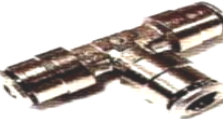
	ΚΩΔΙΚΟΣ	ΔΙΑΣΤΑΣΗ	
	10-210-4	Φ4	ΑΥΤΟΜΑΤΟΣ ΜΕΤΑΛΛΙΚΟΣ ΣΥΝΔΕΣΜΟΣ ΑΕΡΟΣ ΤΑΦ
	10-210-5	Φ5	
	10-210-6	Φ6	
	10-210-8	Φ8	
	10-210-9	Φ9	
	10-210-10	Φ10	
	10-210-11	Φ11	
	10-210-12	Φ12	
	10-210-14	Φ14	
	10-210-16	Φ16	

	ΚΩΔΙΚΟΣ	ΔΙΑΣΤΑΣΗ	
	10-000-4-6	Φ4-Φ6	ΑΥΤΟΜΑΤΟΣ ΜΕΤΑΛΛΙΚΟΣ ΣΥΝΔΕΣΜΟΣ ΑΕΡΟΣ ΣΥΣΤΟΛΙΚΟΣ
	10-000-6-8	Φ6-Φ8	
	10-000-8-10	Φ8-Φ10	
	10-000-10-12	Φ10-Φ12	

	ΚΩΔΙΚΟΣ	ΔΙΑΣΤΑΣΗ	
	10-001-4-6	Φ4-Φ6	ΑΥΤΟΜΑΤΟΣ ΜΕΤΑΛΛΙΚΟΣ ΣΥΝΔΕΣΜΟΣ ΑΕΡΟΣ ΣΥΣΤΟΛΙΚΟΣ ΚΟΡ
	10-001-6-8	Φ6-Φ8	
	10-001-8-10	Φ8-Φ10	
	10-001-10-12	Φ10-Φ12	

ΑΝΟΔΟΣ- ΔΗΜ Ι ΣΟΥΑΝΗΣ

10-ΕΞΑΡΤΗΜΑΤΑ ΑΕΡΟΣ

	ΚΩΔΙΚΟΣ	ΔΙΑΣΤΑΣΗ	
	10-A-000-6	1/8"-Φ6	ΑΥΤΟΜΑΤΟΣ ΜΕΤΑΛΛΙΚΟΣ ΣΥΝΔΕΣΜΟΣ ΑΕΡΟΣ ΒΑΣΕΩΣ ΙΣΙΟ
	10-A-000-8	1/8"-Φ8	
	10-A-000-10	1/8"-Φ10	
	10-0-000-6	1/4"-Φ6	
	10-0-000-8	1/4"-Φ8	
	10-0-000-10	1/4"-Φ10	
	10-0-000-12	1/4"-Φ12	

	10-A-200-6	1/8"-Φ6	ΑΥΤΟΜΑΤΟΣ ΜΕΤΑΛΛΙΚΟΣ ΣΥΝΔΕΣΜΟΣ ΑΕΡΟΣ ΒΑΣΕΩΣ ΓΩΝΙΑ
	10-A-200-8	1/8"-Φ8	
	10-A-200-10	1/8"-Φ10	
	10-0-200-6	1/4"-Φ6	
	10-0-200-8	1/4"-Φ8	
	10-0-200-10	1/4"-Φ10	
	10-2-200-12	3/8"-Φ12	

	10-A-210-6	1/8"-Φ6	ΑΥΤΟΜΑΤΟΣ ΜΕΤΑΛΛΙΚΟΣ ΣΥΝΔΕΣΜΟΣ ΑΕΡΟΣ ΒΑΣΕΩΣ ΑΚΡΗ ΤΑΦ
	10-A-210-8	1/8"-Φ8	
	10-A-210-10	1/8"-Φ10	
	10-0-210-6	1/4"-Φ6	
	10-0-210-8	1/4"-Φ8	
	10-0-210-10	1/4"-Φ10	
	10-2-210-12	3/8"-Φ12	

	10-A-211-6	1/8"-Φ6	ΑΥΤΟΜΑΤΟΣ ΜΕΤΑΛΛΙΚΟΣ ΣΥΝΔΕΣΜΟΣ ΑΕΡΟΣ ΒΑΣΕΩΣ ΜΕΣΗ ΤΑΦ
	10-A-211-8	1/8"-Φ8	
	10-A-211-10	1/8"-Φ10	
	10-0-211-6	1/4"-Φ6	
	10-0-211-8	1/4"-Φ8	
	10-0-211-10	1/4"-Φ10	
	10-2-211-12	3/8"-Φ12	

ΑΝΟΔΟΣ- ΔΗΜ Ι ΣΟΥΑΝΗΣ

10-ΕΞΑΡΤΗΜΑΤΑ ΑΕΡΟΣ

	ΚΩΔΙΚΟΣ	ΔΙΑΣΤΑΣΗ	
	10-0000-4	Φ4	ΑΥΤΟΜΑΤΟΣ ΠΛΑΣΤΙΚΟΣ ΣΥΝΔΕΣΜΟΣ ΑΕΡΟΣ ΙΣΙΟ
	10-0000-5	Φ5	
	10-0000-6	Φ6	
	10-0000-8	Φ8	
	10-0000-7	Φ7	
	10-0000-9	Φ9	
	10-0000-10	Φ10	
	10-0000-11	Φ11	
	10-0000-12	Φ12	
	10-0000-14	Φ14	
	10-0000-15	Φ15	
	10-0000-16	Φ16	

	10-2000-4	Φ4	ΑΥΤΟΜΑΤΟΣ ΠΛΑΣΤΙΚΟΣ ΣΥΝΔΕΣΜΟΣ ΑΕΡΟΣ ΓΩΝΙΑ
	10-2000-5	Φ5	
	10-2000-6	Φ6	
	10-2000-8	Φ8	
	10-2000-9	Φ9	
	10-2000-10	Φ10	
	10-2000-11	Φ11	
	10-2000-12	Φ12	
	10-2000-14	Φ14	
	10-2000-15	Φ15	
	10-2000-16	Φ16	

	10-2100-4	Φ4	ΑΥΤΟΜΑΤΟΣ ΠΛΑΣΤΙΚΟΣ ΣΥΝΔΕΣΜΟΣ ΑΕΡΟΣ ΤΑΦ
	10-2100-5	Φ5	
	10-2100-6	Φ6	
	10-2100-8	Φ8	
	10-2100-9	Φ9	
	10-2100-10	Φ10	
	10-2100-11	Φ11	
	10-2100-12	Φ12	
	10-2100-14	Φ14	
	10-2100-15	Φ15	
	10-2100-16	Φ16	

	10-0000-4-6	Φ4-Φ6	ΑΥΤΟΜΑΤΟΣ ΠΛΑΣΤΙΚΟΣ ΣΥΝΔΕΣΜΟΣ ΑΕΡΟΣ ΣΥΣΤΟΛΙΚΟΣ
	10-0000-6-8	Φ6-Φ8	
	10-0000-8-10	Φ8-Φ10	
	10-0000-10-12	Φ10-Φ12	

	10-0001-4-6	Φ4-Φ6	ΑΥΤΟΜΑΤΟΣ ΠΛΑΣΤΙΚΟΣ ΣΥΝΔΕΣΜΟΣ ΑΕΡΟΣ ΣΥΣΤΟΛΙΚΟΣ ΚΟΡ
	10-0001-6-8	Φ6-Φ8	
	10-0001-8-10	Φ8-Φ10	
	10-0001-10-12	Φ10-Φ12	

ΑΝΟΔΟΣ- ΔΗΜ Ι ΣΟΥΑΝΗΣ

10-ΕΞΑΡΤΗΜΑΤΑ ΑΕΡΟΣ

	ΚΩΔΙΚΟΣ	ΔΙΑΣΤΑΣΗ	
	10-A-0000-6	1/8"-Φ6	ΑΥΤΟΜΑΤΟΣ ΠΛΑΣΤΙΚΟΣ ΣΥΝΔΕΣΜΟΣ ΑΕΡΟΣ ΒΑΣΕΩΣ ΙΣΙΟ
	10-A-0000-8	1/8"-Φ8	
	10-A-0000-10	1/8"-Φ10	
	10-0-0000-6	1/4"-Φ6	
	10-0-0000-8	1/4"-Φ8	
	10-0-0000-10	1/4"-Φ10	
	10-0-0000-12	1/4"-Φ12	

	10-A-2000-6	1/8"-Φ6	ΑΥΤΟΜΑΤΟΣ ΠΛΑΣΤΙΚΟΣ ΣΥΝΔΕΣΜΟΣ ΑΕΡΟΣ ΒΑΣΕΩΣ ΓΩΝΙΑ
	10-A-2000-8	1/8"-Φ8	
	10-A-2000-10	1/8"-Φ10	
	10-0-2000-6	1/4"-Φ6	
	10-0-2000-8	1/4"-Φ8	
	10-0-2000-10	1/4"-Φ10	
	10-0-2000-12	1/4"-Φ12	

	10-A-2100-6	1/8"-Φ6	ΑΥΤΟΜΑΤΟΣ ΠΛΑΣΤΙΚΟΣ ΣΥΝΔΕΣΜΟΣ ΑΕΡΟΣ ΒΑΣΕΩΣ ΑΚΡΗ ΤΑΦ
	10-A-2100-8	1/8"-Φ8	
	10-A-2100-10	1/8"-Φ10	
	10-0-2100-6	1/4"-Φ6	
	10-0-2100-8	1/4"-Φ8	
	10-0-2100-10	1/4"-Φ10	
	10-0-2100-12	1/4"-Φ12	

	10-A-2110-6	1/8"-Φ6	ΑΥΤΟΜΑΤΟΣ ΠΛΑΣΤΙΚΟΣ ΣΥΝΔΕΣΜΟΣ ΑΕΡΟΣ ΒΑΣΕΩΣ ΜΕΣΗ ΤΑΦ
	10-A-2110-8	1/8"-Φ8	
	10-A-2110-10	1/8"-Φ10	
	10-0-2110-6	1/4"-Φ6	
	10-0-2110-8	1/4"-Φ8	
	10-0-2110-10	1/4"-Φ10	
	10-0-2110-12	1/4"-Φ12	

	10-0000-1-6	1/4"	ΑΥΤΟΜΑΤΟΣ ΠΛΑΣΤΙΚΟΣ ΣΥΝΔΕΣΜΟΣ ΑΕΡΟΣ ΙΤΣΑΣ ΙΣΙΟ
	10-0000-1-8	5/16"	
	10-0000-1-10	3/8"	
	10-0000-1-12	1/2"	

	10-2000-1-6	1/4"	ΑΥΤΟΜΑΤΟΣ ΠΛΑΣΤΙΚΟΣ ΣΥΝΔΕΣΜΟΣ ΑΕΡΟΣ ΙΤΣΑΣ ΓΩΝΙΑ
	10-2000-1-8	5/16"	
	10-2000-1-10	3/8"	
	10-2000-10-12	1/2"	

	10-2100-1-6	1/4"	ΑΥΤΟΜΑΤΟΣ ΠΛΑΣΤΙΚΟΣ ΣΥΝΔΕΣΜΟΣ ΑΕΡΟΣ ΙΤΣΑΣ ΤΑΦ
	10-2100-1-8	5/16"	
	10-2100-1-10	3/8"	
	10-2100-112	1/2"	

ΑΝΟΔΟΣ- ΔΗΜ Ι ΣΟΥΑΝΗΣ

10-ΕΞΑΡΤΗΜΑΤΑ ΑΕΡΟΣ

	ΚΩΔΙΚΟΣ	ΔΙΑΣΤΑΣΗ	
	10-000-06	Φ6	ΣΥΝΔΕΣΜΟΣ ΕΡΜΕΤΟ
	10-000-08	Φ8	
	10-000-010	Φ10	

	10-210-06	Φ6	ΤΑΦ ΕΡΜΕΤΟ
	10-210-08	Φ8	
	10-210-010	Φ10	

	10-A-000-06	1/8"-Φ6	ΣΥΝΔΕΣΜΟΣ ΕΡΜΕΤΟ ΒΑΣΕΩΣ ΙΣΙΟ
	10-A-000-08	1/8"-Φ8	
	10-0-000-06	1/4"-Φ6	
	10-0-000-08	1/4"-Φ8	
	10-0-000-010	1/4"-Φ10	
	10-1-000-08	3/8"-Φ8	
	10-1-000-010	3/8"-Φ10	







	10-A-200-06	1/8"-Φ6	ΣΥΝΔΕΣΜΟΣ ΕΡΜΕΤΟ ΒΑΣΕΩΣ ΓΩΝΙΑ
	10-A-200-08	1/8"-Φ8	
	10-0-200-06	1/4"-Φ6	
	10-0-200-08	1/4"-Φ8	
	10-0-200-010	1/4"-Φ10	
	10-1-200-08	3/8"-Φ8	
	10-1-200-010	3/8"-Φ10	

	10-A-210-06	1/8"-Φ6	ΣΥΝΔΕΣΜΟΣ ΕΡΜΕΤΟ ΒΑΣΕΩΣ ΑΚΡΗ ΤΑΦ
	10-A-210-08	1/8"-Φ8	
	10-0-210-06	1/4"-Φ6	
	10-0-210-08	1/4"-Φ8	
	10-0-210-010	1/4"-Φ10	
	10-1-210-08	3/8"-Φ8	
	10-1-210-010	3/8"-Φ10	

	10-A-211-06	1/8"-Φ6	ΣΥΝΔΕΣΜΟΣ ΕΡΜΕΤΟ ΒΑΣΕΩΣ ΜΕΣΗ ΤΑΦ
	10-A-211-08	1/8"-Φ8	
	10-0-211-06	1/4"-Φ6	
	10-0-211-08	1/4"-Φ8	
	10-0-211-010	1/4"-Φ10	
	10-1-211-08	3/8"-Φ8	
	10-1-211-010	3/8"-Φ10	









ΑΝΟΔΟΣ- ΔΗΜ Ι ΣΟΥΑΝΗΣ

10-ΕΞΑΡΤΗΜΑΤΑ ΑΕΡΟΣ

	ΚΩΔΙΚΟΣ	ΔΙΑΣΤΑΣΗ		
	10-1-000A	1/8"	ΝΙΠΕΛ ΑΕΡΟΣ	
	10-1-000	1/4"		
	10-1-002	3/8"		
	10-1-003	1/2"		
	10-1-005	3/4"		
	10-1-006	1"		
	10-1-04000A	1/8"	ΜΟΥΦΑ ΑΕΡΟΣ	
	10-1-04000	1/4"		
	10-1-04002	3/8"		
	10-1-04003	1/2"		
	10-1-04005	3/4"		
	10-1-04006	1"		
	10-1-0000A	1/8"-1/4"	ΝΙΠΕΛ ΣΥΣΤΟΛΙΚΟ ΑΕΡΟΣ	
	10-1-0002	1/4"-3/8"		
	10-1-0003	1/4"-1/2"		
	10-1-0023	3/8"-1/2"		
	10-1-0035	1/2"-3/4"		
	10-1-0056	3/4"-1"		
	10-1-04200A	1/8"	ΠΡΟΕΚΤΑΣΗ ΑΕΡΟΣ	
	10-1-04200	1/4"		
	10-1-04202	3/8"		
	10-1-04233	1/2"		
	10-1-04205	3/4"		
	10-1-04120A	1/8"-1/4"	ΣΥΣΤΟΛΗ ΑΜΕΡΙΚΗΣ	
	10-1-04120	1/4"-3/8"		
	10-1-04130	1/4"-1/2"		
	10-1-04132	3/8"-1/2"		
	10-1-04135	1/2"-3/4"		
	10-1-04156	3/4"-1"		
	10-1-03120	1/4"	Θ-Α-Θ	ΥΨΙΛΟΝ
	10-1-03140	1/4"	Θ-Θ-Θ	
	10-1-0400A	1/8"	ΤΑΠΑ ΑΕΡΟΣ	
	10-1-0400	1/4"		
	10-1-0402	3/8"		
	10-1-0403	1/2"		
	10-1-0405	3/4"		
	10-1-0406	1"		













ΑΝΟΔΟΣ- ΔΗΜ Ι ΣΟΥΑΝΗΣ

10-ΕΞΑΡΤΗΜΑΤΑ ΑΕΡΟΣ

	ΚΩΔΙΚΟΣ	ΔΙΑΣΤΑΣΗ	
	10-1-310A	1/8"	ΓΩΝΙΑ ΑΕΡΟΣ ΑΡΣΕΝΙΚΟ ΘΗΛΥΚΟ
	10-1-310	1/4"	
	10-1-312	3/8"	
	10-1-313	1/2"	
	10-1-0300A	1/8"	ΓΩΝΙΑ ΑΕΡΟΣ ΑΡΣΕΝΙΚΟ ΑΡΣΕΝΙΚΟ
	10-1-0300	1/4"	
	10-1-0302	3/8"	
	10-1-0303	1/2"	
	10-1-0410A	1/8"	ΓΩΝΙΑ ΑΕΡΟΣ ΘΗΛΥΚΟ ΘΗΛΥΚΟ
	10-1-0410	1/4"	
	10-1-0412	3/8"	
	10-1-0413	1/2"	
	10-1-03020A	1/8"	ΤΑΦ ΑΕΡΟΣ Θ-Α-Θ
	10-1-03020	1/4"	
	10-1-03022	3/8"	
	10-1-03023	1/2"	
	10-1-03030A	1/8"	ΤΑΦ ΑΕΡΟΣ Θ-Θ-Α
	10-1-03030	1/4"	
	10-1-03032	3/8"	
	10-1-03033	1/2"	
	10-1-03040A	1/8"	ΤΑΦ ΑΕΡΟΣ Θ-Θ-Θ
	10-1-03040	1/4"	
	10-1-03042	3/8"	
	10-1-03043	1/2"	
	10-1-03050A	1/8"	ΤΑΦ ΑΕΡΟΣ Α-Α-Θ
	10-1-03050	1/4"	
	10-1-03052	3/8"	
	10-1-03053	1/2"	
	10-1-03060A	1/8"	ΤΑΦ ΑΕΡΟΣ Α-Θ-Α
	10-1-03060	1/4"	
	10-1-03062	3/8"	
	10-1-03063	1/2"	









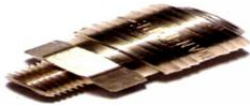

ΑΝΟΔΟΣ- ΔΗΜ Ι ΣΟΥΑΝΗΣ

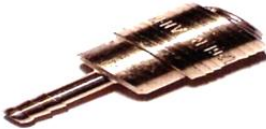
10-ΤΑΧΥΣΥΝΔΕΣΜΟΙ ΑΕΡΟΣ

	ΚΩΔΙΚΟΣ	ΔΙΑΣΤΑΣΗ		
	10-1-100-00	1/4"		ΙΤΑΛΙΚΟΥ ΤΥΠΟΥ ΠΡΙΖΑ ΑΕΡΟΣ ΑΡΣΕΝΙΚΟ ΣΠΕΙΡΩΜΑ
	10-1-100-02	3/8"		
	10-1-100-03	1/2"		
	10-1-100-10	1/4"		ΙΤΑΛΙΚΟΥ ΤΥΠΟΥ ΠΡΙΖΑ ΑΕΡΟΣ ΘΗΛΥΚΟ ΣΠΕΙΡΩΜΑ
	10-1-100-12	3/8"		
	10-1-100-13	1/2"		
	10-1-100-20	Φ6		ΙΤΑΛΙΚΟΥ ΤΥΠΟΥ ΠΡΙΖΑ ΑΕΡΟΣ ΟΥΡΑ
	10-1-100-21	Φ8		
	10-1-100-22	Φ10		
	10-1-100-23	Φ12		
	10-1-100-000	1/4"		ΙΤΑΛΙΚΟΥ ΤΥΠΟΥ ΒΙΣΜΑ ΑΕΡΟΣ ΑΡΣΕΝΙΚΟ ΣΠΕΙΡΩΜΑ
	10-1-100-002	3/8"		
	10-1-100-100	1/4"		ΙΤΑΛΙΚΟΥ ΤΥΠΟΥ ΒΙΣΜΑ ΑΕΡΟΣ ΘΗΛΥΚΟ ΣΠΕΙΡΩΜΑ
	10-1-100-102	3/8"		
	10-1-100-0	Φ6		ΙΤΑΛΙΚΟΥ ΤΥΠΟΥ ΒΙΣΜΑ ΑΕΡΟΣ ΟΥΡΑ
	10-1-100-1	Φ8		
	10-1-100-2	Φ10		
	10-1-100-3	Φ12		
	10-1-100-420	4x6		ΙΤΑΛΙΚΟΥ ΤΥΠΟΥ ΠΡΙΖΑ ΑΕΡΟΣ ΕΛΑΤΗΡΙΟ SPIRAL
	10-1-100-421	6x8		
	10-1-100-422	8x10		
	10-1-100-0420	4x6		ΙΤΑΛΙΚΟΥ ΤΥΠΟΥ ΒΙΣΜΑ ΑΕΡΟΣ ΕΛΑΤΗΡΙΟ SPIRAL
	10-1-100-0421	6x8		
	10-1-100-0422	8x10		
	10-1-100-1420	4x6		ΙΤΑΛΙΚΟΥ ΤΥΠΟΥ ΠΕΡΙΣΤΡΕΦΟΜΕΝΟ 1/4 ΕΛΑΤΗΡΙΟ SPIRAL
	10-1-100-1421	6x8		
	10-1-100-1422	8x10		
	10-1-200-02	3/8"	ΠΡΙΖΑ	ΤΑΧΥΣΥΝΔΕΣΜΟΣ ΑΕΡΟΣ ΓΙΓΑΣ ΜΕΓΑΛΗ ΠΑΡΟΧΗ
	10-1-200-03	1/2"	ΠΡΙΖΑ	
	10-1-200-002	3/8"	ΒΙΣΜΑ	
	10-1-200-003	1/2"	ΒΙΣΜΑ	
	10-9-002-003	ΠΑΡΟΧΕΣ 3	ΠΛΑΓΙΩΣ 3/8"	ΚΟΛΕΚΤΕΡ ΑΕΡΟΣ
	10-9-002-004	ΠΑΡΟΧΕΣ 4	ΠΛΑΓΙΩΣ 3/8"	











ΑΝΟΔΟΣ- ΔΗΜ Ι ΣΟΥΑΝΗΣ

10-ΤΑΧΥΣΥΝΔΕΣΜΟΙ ΑΕΡΟΣ

	ΚΩΔΙΚΟΣ	ΔΙΑΣΤΑΣΗ	
	10-2-100-00	1/4"	ΓΕΡΜΑΝΙΚΟΥ ΤΥΠΟΥ ΠΡΙΖΑ ΑΕΡΟΣ ΑΡΣΕΝΙΚΟ ΣΠΕΙΡΩΜΑ
	10-2-100-02	3/8"	
	10-2-100-03	1/2"	
	10-2-100-10	1/4"	ΓΕΡΜΑΝΙΚΟΥ ΤΥΠΟΥ ΠΡΙΖΑ ΑΕΡΟΣ ΘΗΛΥΚΟ ΣΠΕΙΡΩΜΑ
	10-2-100-12	3/8"	
	10-2-100-13	1/2"	
	10-2-100-20	Φ6	ΓΕΡΜΑΝΙΚΟΥ ΤΥΠΟΥ ΠΡΙΖΑ ΑΕΡΟΣ ΟΥΡΑ
	10-2-100-21	Φ8	
	10-2-100-22	Φ10	
	10-2-100-23	Φ12	
	10-2-100-000	1/4"	ΓΕΡΜΑΝΙΚΟΥ ΤΥΠΟΥ ΒΙΣΜΑ ΑΕΡΟΣ ΑΡΣΕΝΙΚΟ ΣΠΕΙΡΩΜΑ
	10-2-100-002	3/8"	
	10-2-100-200	1/4"	ΓΕΡΜΑΝΙΚΟΥ ΤΥΠΟΥ ΒΙΣΜΑ ΑΕΡΟΣ ΘΗΛΥΚΟ ΣΠΕΙΡΩΜΑ
	10-2-100-202	3/8"	
	10-2-100-0	Φ6	ΓΕΡΜΑΝΙΚΟΥ ΤΥΠΟΥ ΒΙΣΜΑ ΑΕΡΟΣ ΟΥΡΑ
	10-2-100-1	Φ8	
	10-2-100-2	Φ10	
	10-2-100-3	Φ12	
	10-3-100-00	1/4"	ΤΥΠΟΥ ΚΑΒΑΣΑΚΙ ΠΡΙΖΑ ΑΕΡΟΣ ΑΡΣΕΝΙΚΟ ΣΠΕΙΡΩΜΑ
	10-3-100-02	3/8"	
	10-3-100-03	1/2"	
	10-3-100-10	1/4"	ΤΥΠΟΥ ΚΑΒΑΣΑΚΙ ΠΡΙΖΑ ΑΕΡΟΣ ΘΗΛΥΚΟ ΣΠΕΙΡΩΜΑ
	10-3-100-12	3/8"	
	10-3-100-13	1/2"	
	10-3-100-000	1/4"	ΤΥΠΟΥ ΚΑΒΑΣΑΚΙ ΒΙΣΜΑ ΑΕΡΟΣ ΑΡΣΕΝΙΚΟ ΣΠΕΙΡΩΜΑ
	10-3-100-002	3/8"	
	10-3-100-100	1/4"	ΤΥΠΟΥ ΚΑΒΑΣΑΚΙ ΒΙΣΜΑ ΑΕΡΟΣ ΘΗΛΥΚΟ ΣΠΕΙΡΩΜΑ
	10-3-100-102	3/8"	
	10-3-100-0	Φ9	ΤΥΠΟΥ ΚΑΒΑΣΑΚΙ ΒΙΣΜΑ ΑΕΡΟΣ ΟΥΡΑ
	10-3-100-2	Φ11	
	10-3-100-3	Φ14	

ΑΝΟΔΟΣ- ΔΗΜ Ι ΣΟΥΑΝΗΣ

10-ΕΞΑΡΤΗΜΑΤΑ ΑΕΡΟΣ

	ΚΩΔΙΚΟΣ	ΔΙΑΣΤΑΣΗ		
	10-8-1-100MB	1/4"		ΒΑΝΑΚΙ ΑΕΡΟΣ ΘΗΛΥΚΟ ΣΠΕΙΡΩΜΑ
	10-8-1-102MB	3/8"		
	10-8-1-103MB	1/2"		
	10-8-1-100MEB	1/4"		ΒΑΝΑΚΙ ΑΕΡΟΣ ΘΗΛΥΚΟ-ΑΡΣΕΝΙΚΟ ΣΠΕΙΡΩΜΑ
	10-8-1-102MEB	3/8"		
	10-8-1-103MEB	1/2"		
	10-8-1-200	1/4"		ΒΑΝΑΚΙ ΑΕΡΟΣΥΜΠΙΕΣΤΗ
	10-8-1-302	1/4"		ΡΥΘΜΙΣΤΗΣ ΠΙΕΣΗΣ MINI ΑΕΡΟΣΥΜΠΙΕΣΤΗ
	10-8-1-312	3/8"		ΡΥΘΜΙΣΤΗΣ ΠΙΕΣΗΣ ΑΕΡΟΣΥΜΠΙΕΣΤΗ
	10-8-1-313	1/2"		
	10-8-1-322	3/8"		ΦΙΛΤΡΟΛΑΔΙΚΟ ΜΟΝΑΔΑ FRL
	10-8-1-323	1/2"		
	10-8-1-400A	1/8"		ΔΙΑΚΟΠΤΗΣ ΑΕΡΟΣ ΑΝΑΤΡΟΠΗΣ ΤΡΙΟΔΟΣ
	10-8-1-400	1/4"		
	10-8-1-401A	1/8"		ΠΕΝΤΑΟΔΟΣ
	10-8-1-401	1/4"		
	10-4-1001	1/4"	ΘΗΛΥΚΟ	ΒΑΛΒΙΔΑ ΑΝΤΕΠΙΣΤΡΟΦΗΣ
	10-4-1002	3/8"	ΘΗΛΥΚΟ	
	10-4-1003	1/2"	ΘΗΛΥΚΟ	
	10-4-000	1/4"		ΣΚΑΣΤΡΑ ΑΕΡΟΣΥΜΠΙΕΣΤΗ
	10-4-002	3/8"		
	10-4-003	1/2"		
	10-4-100	1-12BAR	220V	ΠΡΕΣΣΟΣΤΑΤΗΣ ΑΕΡΟΣ
	10-4-100A	1-12BAR	380V	

ΑΝΟΔΟΣ- ΔΗΜΙΣΟΥΑΝΗΣ

10-ΡΑΚΟΡ ΑΥΤΟΜ ΝΕΡΟΥ

	ΚΩΔΙΚΟΣ		ΔΙΑΣΤΑΣΗ	
	10-7-0003	ΟΥΡΑ	1/2"	ΟΥΡΑ
	10-7-0005	ΟΥΡΑ	3/4"	
	10-7-0006	ΟΥΡΑ	1"	
	10-7-0007	ΟΥΡΑ	1 1/4"	
	10-7-0008	ΟΥΡΑ	1 1/2"	

	ΚΩΔΙΚΟΣ		ΔΙΑΣΤΑΣΗ	
	10-7-0013	ΘΗΛΥΚΟ	1/2"	ΘΗΛΥΚΟ
	10-7-0015	ΘΗΛΥΚΟ	3/4"	
	10-7-0016	ΘΗΛΥΚΟ	1"	
	10-7-0017	ΘΗΛΥΚΟ	1 1/4"	
	10-7-0018	ΘΗΛΥΚΟ	1 1/2"	

	ΚΩΔΙΚΟΣ		ΔΙΑΣΤΑΣΗ	
	10-7-0023	ΑΡΣΕΝΙΚΟ	1/2"	ΑΡΣΕΝΙΚΟ
	10-7-0025	ΑΡΣΕΝΙΚΟ	3/4"	
	10-7-0026	ΑΡΣΕΝΙΚΟ	1"	
	10-7-0027	ΑΡΣΕΝΙΚΟ	1 1/4"	
	10-7-0028	ΑΡΣΕΝΙΚΟ	1 1/2"	

10-ΓΑΤΟΚΕΦΑΛΑ

	ΚΩΔΙΚΟΣ		ΔΙΑΣΤΑΣΗ	
	10-7-003	ΟΥΡΑ	1/2"	ΟΥΡΑ
	10-7-005	ΟΥΡΑ	3/4"	
	10-7-006	ΟΥΡΑ	1"	
	10-7-007	ΟΥΡΑ	1 1/4"	





	ΚΩΔΙΚΟΣ		ΔΙΑΣΤΑΣΗ	
	10-7-013	ΘΗΛΥΚΟ	1/2"	ΘΗΛΥΚΟ
	10-7-015	ΘΗΛΥΚΟ	3/4"	
	10-7-016	ΘΗΛΥΚΟ	1"	
	10-7-017	ΘΗΛΥΚΟ	1 1/4"	

	ΚΩΔΙΚΟΣ		ΔΙΑΣΤΑΣΗ	
	10-7-023	ΑΡΣΕΝΙΚΟ	1/2"	ΑΡΣΕΝΙΚΟ
	10-7-025	ΑΡΣΕΝΙΚΟ	3/4"	
	10-7-026	ΑΡΣΕΝΙΚΟ	1"	
	10-7-027	ΑΡΣΕΝΙΚΟ	1 1/4"	

	10-7-000			ΕΛΑΣΤΙΚΟ ΠΑΡΕΜΒΑΣΜΑ
---	----------	--	--	--------------------------------



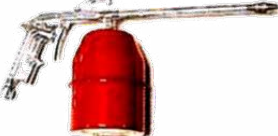







ΑΝΟΔΟΣ- ΔΗΜ Ι ΣΟΥΑΝΗΣ

10-ΕΞΑΡΤΗΜΑΤΑ ΑΕΡΟΣ

	ΚΩΔΙΚΟΣ	ΔΙΑΣΤΑΣΗ	ΣΠΕΙΡΩΜΑ	
	10-5-000	Φ7		ΒΑΛΒΙΔΑ-ΤΣΟΚ ΜΙΝΙ
	10-5-100			ΒΑΛΒΙΔΑ-ΤΣΟΚ ΜΑΚΡΥ ΜΕΣΑ-ΕΞΩ
	10-5-0000	16X1,5-Φ7	16X1,5	ΡΟΖΕΤΑ 16X1,5 ΚΑΖΑΝΑΚΙ
	10-5-1000		16X1,5-1/4"	ΑΝΑΜΟΝΗ 16X1,5 ΚΑΖΑΝΑΚΙ
	10-5-1100		22X1,5	ΕΞΑΕΡΩΤΗΡΑΣ 22X1,5
	10-5-1200	6x4		ΒΑΛΒΙΔΑΚΙ
	10-5-1201	8x6		ΠΛΑΣΤΙΚΟΣΩΛΗΝΑ
	10-5-1300	ΧΟΥΦΤΑ ΑΠΛΗ 16X1,5		ΧΟΥΦΤΑ ΤΡΑΚΤΟΡΑ ΓΕΡΜΑΝΙΑΣ
	10-5-1301	ΧΟΥΦΤΑ ΑΥΤΟΜΑΤΗ 16X1,5		
	10-5-1310	ΧΟΥΦΤΑ ΑΠΛΗ 22X1,5		
	10-5-1311	ΧΟΥΦΤΑ ΑΥΤΟΜΑΤΗ 22X1,5		
	10-6-000	ΠΙΣΤΟΛΙ ΑΕΡΟΣ ΚΟΝΤΟ		ΠΙΣΤΟΛΙ ΑΕΡΟΣ
	10-6-001	ΠΙΣΤΟΛΙ ΑΕΡΟΣ ΜΑΚΡΥ		
	10-6-100	ΑΕΡΟΜΕΤΡΟ ΕΛΑΦΡΟΥ ΤΥΠΟΥ		ΑΕΡΟΜΕΤΡΟ Φ63
	10-6-101	ΑΕΡΟΜΕΤΡΟ ΒΑΡΕΩΣ ΤΥΠΟΥ		
	10-6-200	ΠΙΣΤΟΛΙ ΒΑΦΗΣ ΚΑΤΩ ΔΟΧΕΙΟ		ΠΙΣΤΟΛΙ ΒΑΦΗΣ
	10-6-201	ΠΙΣΤΟΛΙ ΒΑΦΗΣ ΠΑΝΩ ΔΟΧΕΙΟ		
	10-6-300	ΠΕΤΡΕΛΙΕΡΑ		ΠΕΤΡΕΛΙΕΡΑ
	10-6-310	ΑΛΟΥΜΙΝΙΟΥ	1"	ΠΙΣΤΟΛΙ ΠΕΤΡΕΛΑΙΟΥ ΒΕΝΖΙΝΗΣ
	10-6-320	ΑΥΤΟΜΑΤΟ	1"	
	10-6-330	ΒΕΝΖΙΝΗΣ	3/4"	







ΑΝΟΔΟΣ- ΔΗΜ Ι ΣΟΥΑΝΗΣ

10-ΕΞΑΡΤΗΜΑΤΑ ΑΕΡΟΣ

ΚΩΔΙΚΟΣ				
	10-6-400	ΠΙΣΤΟΛΙ ΓΡΑΣΣΟΥ 1/4"		ΠΙΣΤΟΛΙ ΓΡΑΣΣΟΥ
	10-6-500	ΓΡΑΣΣΑΔΩΡΟΣ ΑΕΡΟΣ 1ΚGR		ΓΡΑΣΣΑΔΩΡΟΣ ΑΕΡΟΣ
	10-6-5000	ΓΡΑΣΣΑΔΩΡΟΣ ΧΕΙΡΟΣ 1ΚGR		
	10-6-510	ΓΡΑΣΣΑΔΩΡΟΣ 16ΚGR		ΓΡΑΣΣΑΔΩΡΟΣ ΧΕΙΡΟΚΙΝΗΤΟΣ
	10-6-5200	ΒΑΛΒΟΛΙΝΙΕΡΑ 16ΚGR		ΒΑΛΒΟΛΙΝΙΕΡΑ ΧΕΙΡΟΚΙΝΗΤΗ
	10-6-410	ΑΡΘΡΩΣΗ ΠΙΣΤΟΛΙΟΥ ΓΡΑΣΣΟΥ		ΑΡΘΡΩΣΗ ΠΙΣΤΟΛΙΟΥ ΓΡΑΣΣΟΥ
	10-6-420	ΣΥΡΤΑΡΩΤΟ 1/8"		ΤΣΟΚ ΓΡΑΣΣΑΔΩΡΟΥ
	10-6-421	ΣΥΡΤΑΡΩΤΟ 1/8" CAT Φ16		
	10-6-422	ΣΥΡΤΑΡΩΤΟ 1/8" CAT Φ22		
	10-6-430	ΑΥΤΟΜΑΤΟ 1/8"		
	10-6-440	ΜΥΤΗ ΓΡΑΣΣΑΔΩΡΟΥ ΜΙΚΡΗ		ΜΥΤΗ ΓΡΑΣΣΑΔΩΡΟΥ
	10-6-441	ΜΥΤΗ ΓΡΑΣΣΑΔΩΡΟΥ ΜΕΓΑΛΗ		
	10-6-500A	1/8"	ΙΣΙΟ	ΓΡΑΣΣΑΔΩΡΑΚΙΑ
	10-6-500B	1/4"	ΙΣΙΟ	
	10-6-2-500	6X1	ΙΣΙΟ	
	10-6-2-501	8X1	ΙΣΙΟ	
	10-6-2-502	10X1	ΙΣΙΟ	
	10-6-510A	1/8"	ΓΩΝΙΑ 90*	
	10-6-510B	1/4"	ΓΩΝΙΑ 90*	
	10-6-2-510	6X1	ΓΩΝΙΑ 90*	
	10-6-2-511	8X1	ΓΩΝΙΑ 90*	
	10-6-2-512	10X1	ΓΩΝΙΑ 90*	
	10-6-520A	1/8"	ΓΩΝΙΑ 45*	
	10-6-520B	1/4"	ΓΩΝΙΑ 45*	
	10-6-2-520	6X1	ΓΩΝΙΑ 45*	
	10-6-2-521	8X1	ΓΩΝΙΑ 45*	
	10-6-2-522	10X1	ΓΩΝΙΑ 45*	





ΑΝΟΔΟΣ- ΔΗΜ Ι ΣΟΥΑΝΗΣ

7-ΤΑΧΥΣΥΝΔΕΣΜΟΙ ΚΑΜΛΟΚ



	ΚΩΔΙΚΟΣ	ΔΙΑΣΤΑΣΗ	
	17-1006-A5	1"	KAMLOCK A5 ΑΛΟΥΜΙΝΙΟΥ
	17-1007-A5	1 1/4"	
	17-1008-A5	1 1/2"	
	17-1009-A5	2"	
	17-1009A-A5	2 1/2"	
	17-1009AB-A5	3"	
	17-1009AC-A5	4"	
	17-1006-A7	1"	KAMLOCK A7 ΑΛΟΥΜΙΝΙΟΥ
	17-1007-A7	1 1/4"	
	17-1008-A7	1 1/2"	
	17-1009-A7	2"	
	17-1009A-A7	2 1/2"	
	17-1009AB-A7	3"	
	17-1009AC-A7	4"	
	17-1006-A1	1"	KAMLOCK A1 ΑΛΟΥΜΙΝΙΟΥ
	17-1007-A1	1 1/4"	
	17-1008-A1	1 1/2"	
	17-1009-A1	2"	
	17-1009A-A1	2 1/2"	
	17-1009AB-A1	3"	
	17-1009AC-A1	4"	
	17-1006-A6	1"	KAMLOCK A6 ΑΛΟΥΜΙΝΙΟΥ
	17-1007-A6	1 1/4"	
	17-1008-A6	1 1/2"	
	17-1009-A6	2"	
	17-1009A-A6	2 1/2"	
	17-1009AB-A6	3"	
	17-1009AC-A6	4"	
	17-1006-A2	1"	KAMLOCK A2 ΑΛΟΥΜΙΝΙΟΥ
	17-1007-A2	1 1/4"	
	17-1008-A2	1 1/2"	
	17-1009-A2	2"	
	17-1009A-A2	2 1/2"	
	17-1009AB-A2	3"	
	17-1009AC-A2	4"	
	17-1006-A3	1"	KAMLOCK A3 ΑΛΟΥΜΙΝΙΟΥ
	17-1007-A3	1 1/4"	
	17-1008-A3	1 1/2"	
	17-1009-A3	2"	
	17-1009A-A3	2 1/2"	
	17-1009AB-A3	3"	
	17-1009AC-A3	4"	
	17-1006-A4	1"	KAMLOCK A4 ΑΛΟΥΜΙΝΙΟΥ
	17-1007-A4	1 1/4"	
	17-1008-A4	1 1/2"	
	17-1009-A4	2"	
	17-1009A-A4	2 1/2"	
	17-1009AB-A4	3"	
	17-1009AC-A4	4"	

ΑΝΟΔΟΣ- ΔΗΜ Ι ΣΟΥΑΝΗΣ

17-ΤΑΧΥΣΥΝΔΕΣΜΟΙ ΚΑΜΛΟΚ

	ΚΩΔΙΚΟΣ	ΔΙΑΣΤΑΣΗ	
	17-1006-A8	1"	ΚΑΜΛΟΚ Α8 ΑΛΟΥΜΙΝΙΟΥ
	17-1007-A8	1 1/4"	
	17-1008-A8	1 1/2"	
	17-1009-A8	2"	
	17-1009A-A8	2 1/2"	
	17-1009AB-A8	3"	
	17-1009AC-A8	4"	
	ΣΙΔΕΡΕΝΙΟ		ΚΑΜΛΟΚ ΣΟΒΑ-ΜΠΕΤΟΥ ΣΙΔΕΡΕΝΙΟ Α6
	17-10009-A6	2" Α6	
	ΣΙΔΕΡΕΝΙΟ		ΚΑΜΛΟΚ ΣΟΒΑ-ΜΠΕΤΟΥ ΣΙΔΕΡΕΝΙΟ Α2
	17-10009-A2	2" Α2	
	17-1000-ΚΛ		ΚΛΕΙΣΤΡΑ
	17-1000-OR1	1"-1 1/2"	ΛΑΣΤΙΧΑ ΣΤΕΓΑΝΟΠΟΙΗΣΗΣ ΚΑΜΛΟΚ
	17-1000-OR2	2"-3"	
	17-1000-OR3	4"	

18-ΤΑΧΥΣΥΝΔΕΣΜΟΙ STORZ - ΠΥΡΟΣΒΕΣΤΙΚΑ

	ΚΩΔΙΚΟΣ	ΔΙΑΣΤΑΣΗ	
	18-1006-01	1"	ΤΑΧΥΣΥΝΔΕΣΜΟΙ STORZ ΠΥΡΟΣΒΕΣΤΙΚΑ ΑΛΟΥΜΙΝΙΟΥ
	18-1007-01	1 1/4"	
	18-1008-01	1 1/2"	
	18-1009-01	2"	
	18-1009A-01	2 1/2"	
	18-1009AB-01	3"	
	18-1009AC-01	4"	
	18-1006-02	1"	ΤΑΧΥΣΥΝΔΕΣΜΟΙ STORZ ΠΥΡΟΣΒΕΣΤΙΚΑ ΑΛΟΥΜΙΝΙΟΥ
	18-1007-02	1 1/4"	
	18-1008-02	1 1/2"	
	18-1009-02	2"	
	18-1009A-02	2 1/2"	
	18-1009AB-02	3"	
	18-1009AC-02	4"	
	18-1006-03	1"	ΤΑΧΥΣΥΝΔΕΣΜΟΙ STORZ ΠΥΡΟΣΒΕΣΤΙΚΑ ΑΛΟΥΜΙΝΙΟΥ
	18-1007-03	1 1/4"	
	18-1008-03	1 1/2"	
	18-1009-03	2"	
	18-1009A-03	2 1/2"	
	18-1009AB-03	3"	
	18-1009AC-03	4"	

ΑΝΟΔΟΣ- ΔΗΜ Ι ΣΟΥΑΝΗΣ







2-ΡΑΚΟΡ ΟΡΕΙΧΑΛΚΙΝΑ ΝΕΡΟΥ

	ΚΩΔΙΚΟΣ	ΔΙΑΣ.ΣΩΛΗΝΑ	ΣΠΕΙΡΩΜΑ	
	2-100030	1/2"	1/2"	ΡΑΚΟΡ ΟΡΕΙΧΑΛΚΙΝΟ ΝΕΡΟΥ ΘΗΛΥΚΟ
	2-100050	3/4"	3/4"	
	2-100060	1"	1"	
	2-100070	1 1/4"	1 1/4"	
	2-100080	1 1/2"	1 1/2"	
	2-100090	2"	2"	
	2-100090A	2 1/2"	2 1/2"	
	2-100090B	3"	3"	
	2-100090C	4"	4"	

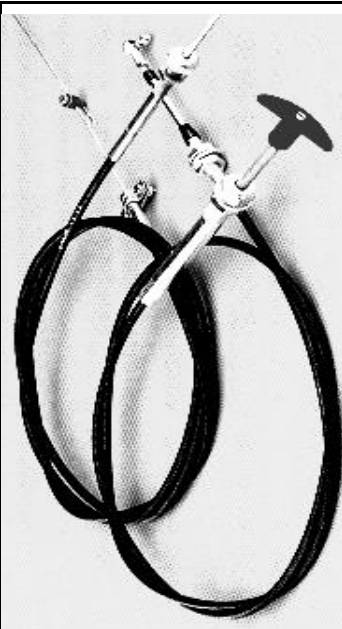
	2-10003	1/2"	1/2"	ΡΑΚΟΡ ΟΡΕΙΧΑΛΚΙΝΟ ΝΕΡΟΥ ΑΡΣΕΝΙΚΟ
	2-10005	3/4"	3/4"	
	2-10006	1"	1"	
	2-10007	1 1/4"	1 1/4"	
	2-10008	1 1/2"	1 1/2"	
	2-10009	2"	2"	
	2-10009A	2 1/2"	2 1/2"	
	2-10009B	3"	3"	
	2-10009C	4"	4"	

ΑΝΟΔΟΣ- ΔΗΜ Ι ΣΟΥΑΝΗΣ

NT-NTIZES

	ΚΩΔΙΚΟΣ	ΔΙΑΣΤΑΣΗ	
	NT-0-200	2,0M	ΣΒΗΣΤΗΡΙ ΑΥΤΟΚΙΝΗΤΟΥ
	NT-0-250	2,5M	
	NT-0-300	3,0M	
	NT-0-350	3,5M	
	NT-0-400	4,0M	
	NT-0-450	4,5M	
	NT-0-500	5,0M	
	NT-0-550	5,5M	
	NT-1-350	3,5M	ΧΕΙΡΙΣΤΗΡΙΟΥ ΒΑΡΕΛΑΣ ΕΝΙΣΧΥΜΕΝΗ
	NT-1-420	4,2M	
	NT-1-450	4,5M	
	NT-1-500	5,0M	
	NT-1-550	5,5M	
	NT-1-600	6,0M	
	NT-1-650	6,5M	
	NT-1-700	7,0M	
	NT-1-750	7,5M	
	NT-1-800	8,0M	
	NT-2-15	1,5mm	ΝΤΙΖΕΣ ΕΣΩΤΕΡΙΚΟ ΣΥΡΜΑ ΠΛΕΚΤΟ ΑΣΠΡΟ
	NT-2-20	2,0mm	
	NT-2-25	2,5mm	
	NT-2-30	3,0mm	
	NT-2-35	3,5mm	
	NT-2-40	4,0mm	
	NT-2-45	4,5mm	
	NT-2-50	5,0mm	
	NT-21-35	3,5mm	ΝΤΙΖΕΣ ΕΣΩΤΕΡΙΚΟ ΣΥΡΜΑ ΠΟΛΥΚΛΩΝΟ ΜΕ ΕΞΩΤΕΡΙΚΟ ΚΑΛΥΜΑ
	NT-21-40	4,0mm	
	NT-21-42	4,2mm	
	NT-21-45	4,75mm	
	NT-21-55INOX	5,5mm	
	NT-3-80	8,0mm	ΝΤΙΖΕΣ ΕΞΩΤΕΡΙΚΟ ΜΑΥΡΟ
	NT-3-95	9,5mm	
	NT-3-105	10,5mm	
	NT-3-115	11,5mm	
	NT-32-6-2	6X2	ΝΤΙΖΕΣ ΕΞΩΤΕΡΙΚΟ ΜΑΥΡΟ ΕΛΑΦΡΟΥ ΤΥΠΟΥ
	NT-32-6-4	6X4	
	NT-32-8-5	8X5	
	NT-32-10-7	10X7	

ΑΝΟΔΟΣ- ΔΗΜ Ι ΣΟΥΑΝΗΣ

NT-NTIZEΣ

	ΚΩΔΙΚΟΣ	ΔΙΑΣΤΑΣΗ	ΣΠΕΙΡΩΜΑ	
	NT-A-12		12X1,5	ΑΡΘΡΩΣΗ
	NT-Δ-5	L=10MM	5X0,8	ΔΙΧΑΛΟ
	NT-Δ-15	L=20MM	5X0,8	
	NT-Δ-6	L=12MM	6x1,0	
	NT-Δ-16	L=24MM	6x1,0	
	NT-Δ-8	L=16MM	8X1,25	
	NT-Δ-18	L=32MM	8X1,25	
	NT-Δ-10	L=20MM	10X1,5	
	NT-Δ-110	L=40MM	10X1,5	
	NT-Δ-12	L=24MM	12x1,75	
	NT-Δ-112	L=48MM	12x1,75	
	NT-Δ-16	L=32MM	16x2,0	
NT-Δ-116	L=64MM	16x2,0		
	NT-ΜΠ-Γ-5		5X0,8	ΜΠΑΛΑΚΙ ΔΕΞΙ ΣΠΕΙΡΩΜΑ
	NT-ΜΠ-Γ-6		6x1,0	
	NT-ΜΠ-Γ-8		8X1,25	
	NT-ΜΠ-Γ-10		10X1,5	
	NT-ΜΠ-Γ-12		12X1,75	
	NT-ΜΠ-Γ-50		5X0,8	ΜΠΑΛΑΚΙ ΑΡΙΣΤΕΡΟ ΣΠΕΙΡΩΜΑ
	NT-ΜΠ-Γ-60		6x1,0	
	NT-ΜΠ-Γ-80		8X1,25	
	NT-ΜΠ-Γ-100		10X1,5	
	NT-Σ-00		2MM	ΣΦΥΚΤΗΡΑΚΙ ΝΤΙΖΑΣ
	NT-Σ-01		3MM	
	NT-Σ-02	ΔΙΠΛΗ ΒΙΔΑ	3MM	
	NT-K-6		6X1,0	ΚΑΝΟΝΑΣ
	NT-A-6		6X1,0	ΑΞΟΝΑΚΙ ΝΤΙΖΑΣ
	NT-A-8		8X1,25	
	NT-A-10		10X1,5	
	NT-AK-10		10X1,0	ΑΚΡΟ ΝΤΙΖΑΣ
	NT-AK-12		12X1,0	
	NT-AK-16		16X1,5	
	NT-AK-18		18X1,5	

ΑΝΟΔΟΣ- ΔΗΜΙΣΟΥΑΝΗΣ

NT-NTIZES

ΚΩΔΙΚΟΣ



NT-X-1

ΧΕΙΡΙΣΤΗΡΙΟ ΜΟΝΟ

**ΧΕΙΡΙΣΤΗΡΙΟ
ΝΤΙΖΑΣ ΒΑΡΕΛΑΣ**



NT-X-2

ΧΕΙΡΙΣΤΗΡΙΟ ΔΙΠΛΟ

**ΧΕΙΡΙΣΤΗΡΙΟ
ΝΤΙΖΑΣ ΒΑΡΕΛΑΣ**

NT-X-10
NT-X-010

**ΧΕΙΡΙΣΤΗΡΙΟ ΜΙΚΡΟ ΓΚΑΖΙΟΥ
ΧΕΙΡΙΣΤΗΡΙΟ ΜΙΚΡΟ ΑΛΛΕΝ**

**ΧΕΙΡΙΣΤΗΡΙΟ
ΝΤΙΖΑΣ**

NT-X-11

ΧΕΙΡΙΣΤΗΡΙΟ ΚΟΥΜΠΩΤΟ

ΔΟΝΗΤΕΣ ΜΠΕΤΟΥ

ΕΤΟΙΜΟΙ-ΚΑΤΑΣΚΕΥΕΣ-ΕΠΙΣΚΕΥΕΣ

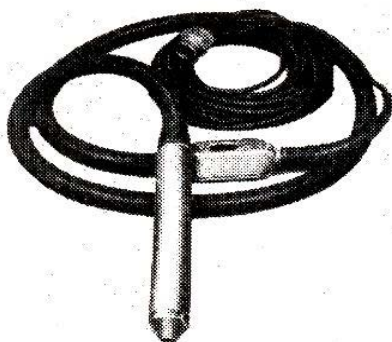

NT-ΔON-01



ΔΟΝΗΤΗΣ ΜΠΕΤΟΥ ΒΑΡΕΩΣ ΤΥΠΟΥ

NT-ΔON-02

ΔΟΝΗΤΗΣ ΜΠΕΤΟΥ



ΑΝΟΔΟΣ- ΔΗΜ Ι ΣΟΥΑΝΗΣ

11-ΣΦΙΓΚΤΗΡΕΣ

	ΚΩΔΙΚΟΣ	ΔΙΑΣΤΑΣΗ		
	11-0-001	8X12	ΣΦΙΓΚΤΗΡΕΣ ΑΠΛΟΙ ΓΑΛΒΑΝΙΖΕ	
	11-0-002	8X16		
	11-0-003	12X22		
	11-0-004	16X27		
	11-0-005	20X32		
	11-0-006	25X40		
	11-0-007	32X50		
	11-0-008	40X60		
	11-0-009	50X70		
	11-0-010	60X80		
	11-0-011	70X90		
	11-0-012	80X100		
	11-0-013	90X110		
	11-0-014	100X120		
	11-0-015	120X140		
	11-0-016	130X150		
	11-1-001	17-19	ΣΦΙΓΚΤΗΡΕΣ ΒΑΡΕΩΣ ΤΥΠΟΥ ΓΑΛΒΑΝΙΖΕ	
	11-1-002	20-22		
	11-1-003	23-25		
	11-1-004	26-28		
	11-1-005	29-31		
	11-1-006	32-35		
	11-1-007	36-39		
	11-1-008	40-43		
	11-1-009	44-47		
	11-1-010	48-51		
	11-1-011	52-55		
	11-1-012	56-59		
	11-1-013	60-63		
	11-1-014	64-67		
	11-1-015	68-73		
	11-1-016	74-79		
	11-1-017	80-85		
	11-1-018	86-91		
	11-1-019	92-97		
	11-1-020	98-103		
	11-1-021	104-112		
	11-1-022	113-121		
	11-1-023	122-130		
	11-1-024	131-139		
	11-1-025	140-148		
	11-1-026	149-161		
	11-1-027	162-174		
	11-2-001	1/2"	29	ΣΦΙΓΚΤΗΡΕΣ ΒΑΡΕΩΣ ΤΥΠΟΥ ΜΕ ΔΥΟ ΒΙΔΕΣ
	11-2-002	3/4"	34	
	11-2-003	1"	40	
	11-2-004	1 1/4"	48	
	11-2-005	1 1/2"	60	
	11-2-006	2"	76	

ΑΝΟΔΟΣ- ΔΗΜ Ι ΣΟΥΑΝΗΣ

11-ΣΦΙΓΚΤΗΡΕΣ

	ΚΩΔΙΚΟΣ	ΔΙΑΣΤΑΣΗ	
	11-0-001-IN	8X12	ΣΦΙΓΚΤΗΡΕΣ ΑΠΛΟΙ ΙΝΟΧ
	11-0-002-IN	8X16	
	11-0-003-IN	12X22	
	11-0-004-IN	16X27	
	11-0-005-IN	20X32	
	11-0-006-IN	25X40	
	11-0-007-IN	32X50	
	11-0-008-IN	40X60	
	11-0-009-IN	50X70	
	11-0-010-IN	60X80	
	11-0-011-IN	70X90	
	11-0-012-IN	80X100	
	11-0-013-IN	90X110	
	11-0-014-IN	100X120	
	11-0-015-IN	120X140	
	11-0-016-IN	130X150	
	11-1-001-IN	17-19	ΣΦΙΓΚΤΗΡΕΣ ΒΑΡΕΩΣ ΤΥΠΟΥ ΙΝΟΧ
	11-1-002-IN	20-22	
	11-1-003-IN	23-25	
	11-1-004-IN	26-28	
	11-1-005-IN	29-31	
	11-1-006-IN	32-35	
	11-1-007-IN	36-39	
	11-1-008-IN	40-43	
	11-1-009-IN	44-47	
	11-1-010-IN	48-51	
	11-1-011-IN	52-55	
	11-1-012-IN	56-59	
	11-1-013-IN	60-63	
	11-1-014-IN	64-67	
	11-1-015-IN	68-73	
	11-1-016-IN	74-79	
	11-1-017-IN	80-85	
	11-1-018-IN	86-91	
	11-1-019-IN	92-97	
	11-1-020-IN	98-103	
	11-1-021-IN	104-112	
	11-1-022-IN	113-121	
	11-1-023-IN	122-130	
	11-1-024-IN	131-139	
	11-1-025-IN	140-148	
	11-1-027-IN	162-174	

ΑΝΟΔΟΣ- ΔΗΜ Ι ΣΟΥΑΝΗΣ

12-ΡΟΔΕΛΕΣ

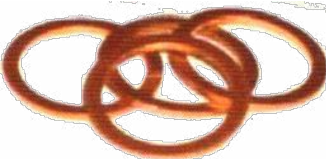
	ΚΩΔΙΚΟΣ	ΔΙΑΣΤΑΣΗ	
	12-0-000-6		ΡΟΔΕΛΑ ΧΑΛΚΟΥ
	12-0-000-8		
	12-0-000-10		
	12-0-000-12		
	12-0-000-12A	12,5MM	
	12-0-000-13	1/4"	
	12-0-000-14		
	12-0-000-16		
	12-0-000-17	3/8"	
	12-0-000-18		
	12-0-000-19		
	12-0-000-20		
	12-0-000-21	1/2"	
	12-0-000-22		
	12-0-000-24		
	12-0-000-26		
	12-0-000-26A	3/4"	
	12-0-000-28		
	12-0-000-30		
	12-0-000-32		
	12-0-000-33	1"	
	12-0-000-34		
	12-0-000-36		
	12-0-000-38		
	12-0-000-40		
	12-0-000-42	1 1/4"	
	12-0-000-45		
12-0-000-48	1 1/2"		
12-0-000-60	2"		

	12-1-000-9		ΡΟΔΕΛΑ ΜΕ ΕΛΑΣΤΙΚΟ ΔΑΚΤΥΛΙΟ NRB
	12-1-000-10		
	12-1-000-12		
	12-1-000-13	1/4"	
	12-1-000-14		
	12-1-000-16		
	12-1-000-17	3/8"	
	12-1-000-18		
	12-1-000-20		
	12-1-000-21	1/2"	
	12-1-000-22		
	12-1-000-24		
	12-1-000-26		
	12-1-000-26A	3/4"	
	12-1-000-33	1"	
	12-1-000-42	1 1/4"	
	12-1-000-48	1 1/2"	
12-1-000-60	2"		

ΑΝΟΔΟΣ- ΔΗΜΙΣΟΥΑΝΗΣ

14-ΜΗΧΑΝΗΜΑΤΑ ΠΡΕΣΑΡΙΣΜΑΤΟΣ ΕΛΑΣΤΙΚΩΝ ΣΩΛΗΝΩΝ ΠΙΕΣΕΩΣ

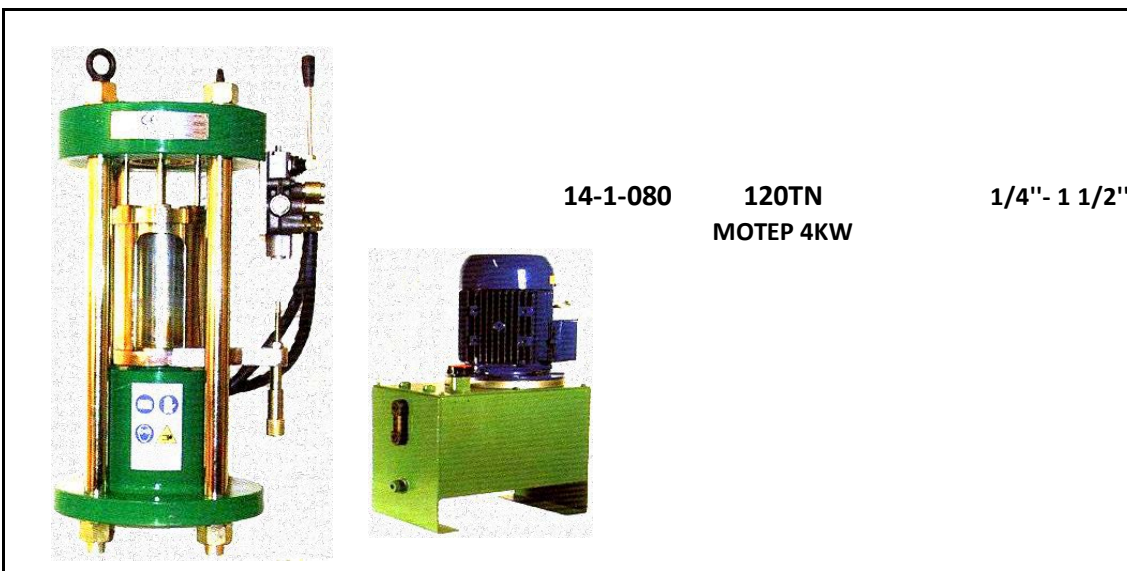
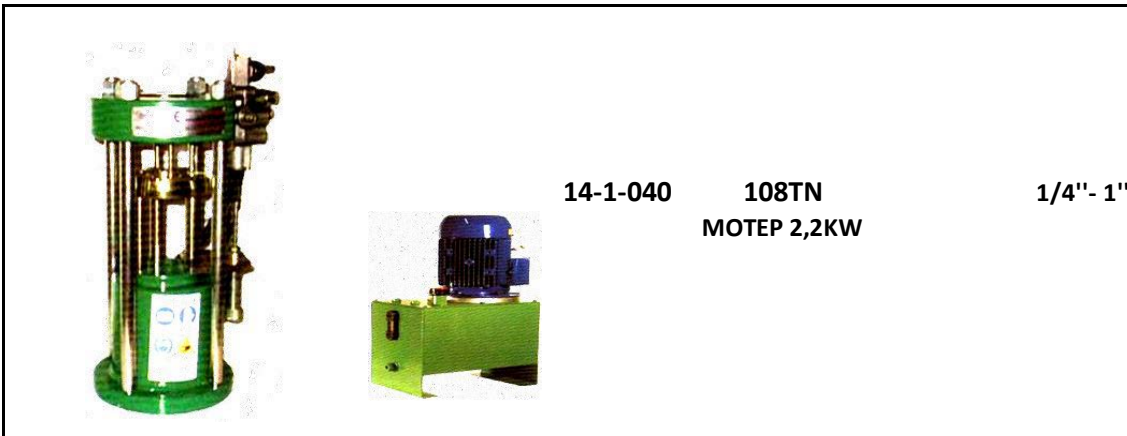
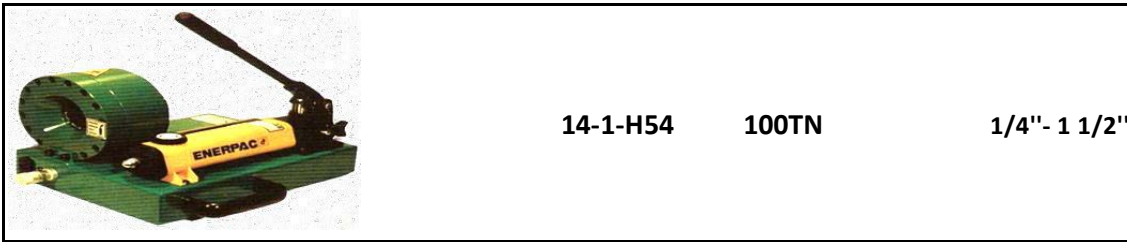

ΚΩΔΙΚΟΣ



ΑΝΟΔΟΣ- ΔΗΜ Ι ΣΟΥΑΝΗΣ

14-ΜΗΧΑΝΗΜΑΤΑ ΠΡΕΣΑΡΙΣΜΑΤΟΣ ΕΛΑΣΤΙΚΩΝ ΣΩΛΗΝΩΝ ΠΙΕΣΕΩΣ

ΚΩΔΙΚΟΣ

	14-1-265	260TN ΜΟΤΕΡ 4KW	1/4"- 2"
			

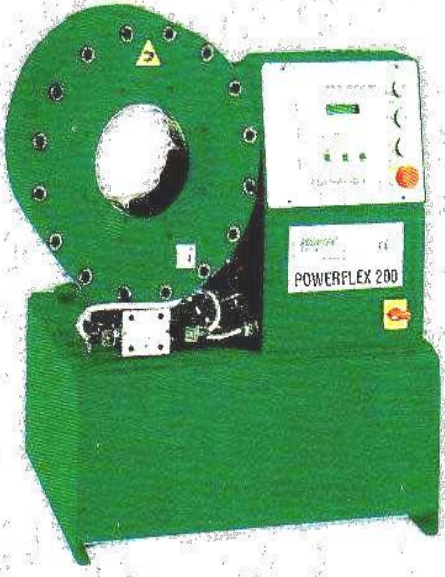
	14-1-H79ES 200TN	ΜΟΤΕΡ 4KW	1/4"- 3"
		ΗΛΕΚΤΡΟΝΙΚΟ ΧΕΙΡΙΣΤΗΡΙΟ	
	14-1-H79EL 200TN	ΜΟΤΕΡ 4KW	1/4"- 3"
		ΗΛΕΚΤΡΙΚΟ ΧΕΙΡΙΣΤΗΡΙΟ	
	14-1-H80ES 245TN	ΜΟΤΕΡ 5,5KW	1/4"- 3"
		ΗΛΕΚΤΡΟΝΙΚΟ ΧΕΙΡΙΣΤΗΡΙΟ	
	14-1-H80EL 245TN	ΜΟΤΕΡ 5,5KW	1/4"- 3"
		ΗΛΕΚΤΡΙΚΟ ΧΕΙΡΙΣΤΗΡΙΟ	

